

SECTION 8

MOTORIST SERVICE SIGNS

March 2010

CONTENTS

	Page Number	Page Date
SECTION 8: MOTORIST SERVICE SIGNS (Design, Policy And Location)		
8.1 INTRODUCTION		
8.1.1 GENERAL	8-1	Aug 2006
8.1.2 SCOPE	8-1	"
8.1.3 DEFINITIONS	8-1	"
8.1.4 SIGN COLOURS	8-2	Mar 2007
8.1.5 SIGNS	8-2	"
8.1.6 SIGNING POLICY	8-2	"
8.2 SIGN DETAILS		
8.2.1 GENERAL	8-3	Aug 2006
8.2.2 MOTORIST SERVICE SIGN IDENTIFICATION SYSTEM	8-3	"
8.2.3 COLOURS	8-3	"
8.2.4 SHAPE	8-3	"
8.2.5 SIZE	8-4	"
8.2.6 MOTORIST SERVICE SYMBOLS	8-4	"
TABLE 8.1 GRID MODULE SIZES FOR MOTORIST SERVICE SIGNS	8-4	"
8.2.7 LETTER STYLE AND SIZE	8-4	"
8.2.8 DISTANCES	8-4	"
8.2.9 BORDERS	8-4	"
8.2.10 DESIGN VARIATIONS	8-4	"
8.2.11 EXAMPLES OF MOTORISTS SERVICE SIGNS	8-4	"
FIGURE 8.1 ADVANCE SIGNS FOR SERVICE ADJACENT TO THE ROAD	8-5	"
FIGURE 8.2 ADVANCE SIGNS FOR SERVICE ON A SIDE ROAD	8-5	"
FIGURE 8.3 POSITION SIGNS FOR A SINGLE SERVICE	8-5	"
FIGURE 8.4 CHEVRON TYPE POSITION SIGNS FOR MULTIPLE SERVICES	8-5	"
FIGURE 8.5 A NARROW FORMAT POSITION SIGN FOR MULTIPLE SERVICES	8-5	"
8.3 SIGN PROVISION CONDITIONS		
8.3.1 INTRODUCTION	8-6	"
8.3.2 GENERAL CONDITIONS FOR THE PROVISION OF MOTORISTS SERVICE SIGN	8-6	"
8.3.3 ADVANCE SIGNS	8-6	"
8.3.4 POSITION SIGNS	8-6	"
FIGURE 8.6 FLOWCHART TO DETERMINE THE SIGNING REQUIRED FOR MOTORIST SERVICE	8-7	"
8.4 SIGNING REQUIREMENTS		
8.4.1 ADVANCE SIGNS	8-8	"
8.4.2 POSITION SIGNS	8-8	"
8.4.3 COMBINED DIRECTION , MOTORIST SERVICE AND TOURIST SIGNS	8-8	"

8.5 APPLICATION

8.5.1	THE REST AREAS	8-9	May 2008
TABLE 8.2	SYMBOLS WHICH MAY BE USED ON REST AREA SIGNS	8-9	Aug 2006
FIGURE 8.7	EXAMPLES OF ADVANCE SIGNS FOR REST AREAS ADJACENT TO THE ROAD	8-9	"
FIGURE 8.8	EXAMPLES OF ADVANCE SIGNS FOR REST AREAS LOCATED ON A SIDE ROAD	8-9	"
FIGURE 8.9	EXAMPLES OF POSITIONS SIGNS FOR REST AREAS	8-9	"
FIGURE 8.10 & 10a	TYPICAL SIGNING FOR REST AREA	8-10	Mar 2010
8.5.2	COMMERCIAL SERVICES	8-11	"
TABLE 8.3	SYMBOLS WHICH MAY BE USED TO INDICATE COMMERCIAL SERVICES	8-11	"
FIGURE 8.11	A TYPICAL ADVANCE SIGN FOR A SERVICE CENTRE	8-12	"
FIGURE 8.12	TYPICAL SIGNING FOR COMMERCIAL SERVICES ON A DIVIDED ROAD	8-12	"
FIGURE 8.13	TYPICAL SIGNING FOR COMMERCIAL SERVICES ON A SIDE ROAD	8-12	"
8.5.3	ACCOMMODATION SERVICES	8-13	"
8.5.4	INFORMATION SERVICES	8-13	"
FIGURE 8.14	EXAMPLES OF ADVANCE SIGNS FOR INFORMATION SERVICES	8-14	"
FIGURE 8.15	TYPICAL SIGNING FOR UNATTENDED INFORMATION FACILITIES	8-15	"
FIGURE 8.16	TYPICAL SIGNING FOR ATTENDED INFORMATION FACILITIES	8-16	"
8.5.5	OTHER SERVICES	8-17	"
TABLE 8.4	LOCAL SERVICES WHICH MAY BE INDICATED BY SYMBOLS ON MOTORIST SERVICE SIGNS	8-17	"
FIGURE 8.17	PARK AND RIDE SIGN SYMBOL COMBINATIONS	8-17	"
8.5.6	SERVICES IN BYPASSED COMMUNITIES	8-18	"
FIGURE 8.18	TYPICAL SIGNING FOR MOTORIST SERVICES IN A BYPASSED COMMUNITY	8-19	"

8.6 SIGN DESIGN AND LAYOUT

8.6.1	INTRODUCTION	8-20	"
8.6.2	SYMBOLS	8-20	"
8.6.3	SIGN DESIGN PROCEDURE	8-20	"
8.6.4	RECTANGULAR SIGN DESIGN	8-20	"
FIGURE 8.19	A TYPICAL RECTANGULAR SIGN LAYOUT	8-20	"
8.6.5	CHEVRON SIGN DESIGN	8-21	"
FIGURE 8.20	A TYPICAL CHEVRON SIGN LAYOUT	8-21	"
TABLE 8.5	STANDARD DIMENSIONS FOR CHEVRON TYPE SIGNS (mm)	8-21	"

8.7 MOTORIST SERVICE SYMBOLS

FIGURE 8.21	MOTORIST SERVICE SYMBOLS	8-22	Aug 2006
FIGURE 8.22	MOTORIST SERVICE SYMBOLS S1 AND S2	8-23	"
FIGURE 8.23/23a	MOTORIST SERVICE SYMBOLS S3, S4 AND S4a	8-24/8-24a	Mar 2010
FIGURE 8.24	MOTORIST SERVICE SYMBOLS S5 AND S6	8-25	"
FIGURE 8.25	MOTORIST SERVICE SYMBOLS S7 AND S8	8-26	"
FIGURE 8.26	MOTORIST SERVICE SYMBOLS S9 AND S10	8-27	"
FIGURE 8.27	MOTORIST SERVICE SYMBOLS S11 AND S12	8-28	"
FIGURE 8.28	MOTORIST SERVICE SYMBOLS S13 AND S14	8-29	"
FIGURE 8.29	MOTORIST SERVICE SYMBOLS S15 AND S16	8-30	"
FIGURE 8.30	MOTORIST SERVICE SYMBOLS S17 AND S18	8-31	"
FIGURE 8.31	MOTORIST SERVICE SYMBOLS S19 AND S20	8-32	"

8.8 SIGN DESIGNATION, MAXIMUM SIZES AND TYPICAL SIGN LAYOUTS

8.8.1	MOTORIST SERVICE SIGN DESIGNATION AND MAXIMUM SIZES	8-33	"
TABLE 8.6	MOTORIST SERVICE SIGN DESIGNATION AND MAXIMUM SIZES	8-33	"
FIGURE 8.32	TYPICAL LAYOUTS FOR MS-1.1 AND MS-1.2 SIGNS	8-34	"
FIGURE 8.33	TYPICAL LAYOUTS FOR MS-1.3 AND MS-2.1 SIGNS	8-35	"
FIGURE 8.34	TYPICAL LAYOUTS FOR MS-2.2 AND MS-3.1 SIGNS	8-36	"
FIGURE 8.35	TYPICAL LAYOUT FOR AN MS-3.3 SIGN	8-37	"
FIGURE 8.36	TYPICAL LAYOUT FOR MS-4.1 AND MS 4.3 SIGNS	8-38	"
FIGURE 8.37	TYPICAL LAYOUT FOR AN MS-4.4 SIGN	8-39	"

8.1 INTRODUCTION

8.1.1 GENERAL

This section of the Manual sets out the requirements for signing Motorist Services on New Zealand State Highways.

It is recommended that all local road controlling authorities adopt these requirements for the signing of motorist services on roads under their control, to ensure consistency in traffic signing throughout New Zealand.

Motorist service signs are detailed in the MS sign series and form part of the overall state highway traffic signing system. These signs are not intended to guide travellers through the roading system and they must only be used to indicate the services defined as motorist services in Section 8.1.3 (b) below, **when those services are not obvious to travellers on the road.**

The basic assumptions made for guiding travellers through any roading system are:

- *Some preparation will have been done before a journey is commenced, and*
- *A road map will be used to determine the route to be followed.*

The most appropriate method to indicate motorist services is therefore to:

- provide a roading system with route numbering and clear, consistent guide signing, and
- only add motorist service signing in the immediate vicinity of a service, or service facility.

The application of the principles set out in this section of the Manual will ensure a consistent and appropriate level of motorist service signing on all New Zealand roads.

8.1.2 SCOPE

This section of the manual covers the provision of motorist service signing on all roads other than motorways.

Details are given for:

- the provision, location and installation of motorist service signs, and
- the illumination and reflectorisation of these signs.

8.1.3 DEFINITIONS

The following definitions apply in this section of the Manual:

(a) SPEED or 85th PERCENTILE SPEED

The speed at or below which 85 percent of vehicles are observed to travel, under free flowing conditions, past a nominated point.

A vehicle is considered to be operating under free-flowing conditions when the preceding vehicle has at least a 6 second headway, and there is no apparent attempt to overtake the vehicle ahead.

NOTES:

1. **All types of vehicles on the road should be included in speed surveys.**
2. **Speed measurements should be made by unobtrusive means, such as a suitably hidden radar device.**
3. **Speeds should be measured well in advance of a motorist service location, ie. approximately 200m in urban areas and 500m in rural areas.**
4. **Refer to the AUSTROADS "Guide to Traffic Engineering Practice: Part 3 - Traffic Studies" for more details on speed surveys.**

(b) MOTORIST SERVICE

A motorist service is defined a service which:

- is commonly required by travellers, and
- is located adjacent to the road, or a reasonable distance along a side road, and
- can be identified by an internationally recognised symbol.

For New Zealand state highways the only services that meet this definition are:

- 1 **Rest areas**
- 2 **Accommodation:** *Lodges, hotels, motels, guest houses, etc.*
- 3 **Camping grounds**
- 4 **Caravan parks**
- 5 **Camping ground and caravan parks**
- 6 **Motor fuel:** *Petrol, diesel, LPG and CNG.*
- 7 **Motor fuel and repairs**
- 8 **Refreshments:** *Light meals, cafeterias, etc.*
- 9 **Meals:** *Restaurants and licensed restaurants*
- 10 **Information:** This includes:
 - **Official information centres,** and
 - **Unattended roadside facilities** such as: *Information Bays, Information boards within rest areas, Town/District maps, etc.*
- 11 **Emergency medical services:** *Only when available on a 24 hour basis.*
- 12 **Public telephones**
- 13 **Public toilets**
- 14 **Waste disposal points:** *Campervans and caravans only.*
- 15 **Public parking areas**
- 16 **Truck parking areas**
- 17 **Truck trailer parking areas**

18 Airfields: *May also be used as a symbol on airport route marker signs, when AIRPORT is not shown as a destination on guide signs.*

19 Boat Ramps

20 Wheelchair access

21 Youth Hostel Association: *This is a copyrighted symbol and **MUST** only be used to indicate a YHA facility. Symbol details are available from Transit New Zealand offices.*

(c) SIGN GROUPS

Motorist services considered to have similar characteristics have been grouped for signing purposes. These groups are:

- **Rest areas**
- **Commercial services**
- **Accommodation services**
- **Information services**
- **Other services**
- **Bypassed communities**

8.1.4 SIGN COLOURS

Motorist service signs have white borders, symbols and worded legends (when appropriate), on blue backgrounds.

8.1.5 SIGNS

Motorist service signs are described in the MS signs series and are detailed in two sizes, ie. A-size signs for use in low speed environments and larger B-size signs for use in all other situations.

Two types of MS sign are used, advance signs and position signs:

(a) ADVANCE SIGNS

Rectangular shaped signs that inform travellers of services on the road ahead, or on a side road.

(b) POSITION SIGNS

Signs which mark the location of a service adjacent to the road or the turn-off to a service on a side road. These signs may have:

- a pointed end with a chevron direction indicator, or
- be rectangular in shape with an arrow direction indicator.

8.1.6 SIGNING POLICY

(a) WARRANTS

Motorist service signs shall not be provided unless:

- the service is one of those defined as a motorist service in Section 8.1.3 (b), and
- all the requirements of Section 8.3: *Sign Provision Conditions* are met.

(b) PROVISION OF SIGNS

The state highway roading authority will normally install, at its cost, state highway motorist service signing for facilities and services provided by non-profit making organisations. The cost of installing motorist service signing for facilities and services provided by other organisations should be met by the relevant organisation.

The cost of maintenance of state highway motorist service signs will be borne by the state highway roading authority in all cases.

(c) PROVISION OF SIGNS AT INTERSECTIONS WHERE TWO OR MORE CONTROLLING AUTHORITIES ARE INVOLVED

At the intersections of roads controlled by different roading authorities, one road should be designated the "main" road and the other the "side" road.

In these situations the provision and maintenance of motorist service signs should be:

- as specified in Section 8.1.6 (b) above for the "main" road, and
- by the roading authority responsible for the "side" road. The "side" road is considered to start from the boundary line of the "main" road reserve at the intersection.

8.2 SIGN DETAILS

8.2.1 GENERAL

(a) Motorist service signs have:

- Services identified by symbols. A symbol may be supplemented by a one or two word descriptor in some specific situations, to further identify the particular type of service.
- Worded distance legends on advance signs.
- Lettering not less than 120 mm high, in Series D or E CAPITALS.
- Borders that extend to the edges of signs.
- Signboards with all corners rounded. The normal corner radius is approximately 0.125 times the smallest dimension of the signboard and a 20 mm minimum radius should be used on the pointed end of chevron type signs.
- No support framing or edge stiffening extending beyond the outlines of signboards, including the rounded corners.

(b) REFLECTORISATION

When a service is available by day and night motorist service signs should be fully reflectorised.

Motorist service signs may also be fully reflectorised when enhanced sign durability can be economically justified.

(c) TYPICAL SIGNS

Typical motorist service sign layouts are illustrated in Figures 8.1, 8.2, 8.3, 8.4 and 8.5.

The full list of motorist service signs is given in Section 8.8: *Sign Designation, Maximum Sizes and Typical Sign Layouts*.

8.2.2 MOTORIST SERVICE SIGN IDENTIFICATION SYSTEM

Motorist service signs are in the MS sign series. They are identified by the MS letter prefix, a numbering system and a letter suffix, eg. MS - 1.2A, which defines the type of sign, number of symbols shown and sign size, in the following manner:

(a) FIRST NUMBER - SIGN TYPE

- 1 A rectangular shaped advance warning sign to indicate motorist services located adjacent to the road, containing symbols and a word message which may be either:
 - **300 m ON LEFT**, or
 - **300 m ON RIGHT**

- 2 A rectangular shaped advance warning sign to indicate motorist services located on a side road, containing symbols and a word message which may be either:
 - **TURN LEFT 300 m**, or
 - **TURN RIGHT 300 m**

- 3 A pointed end position sign with a chevron stripe to indicate motorist services adjacent to the road, or down a side road.

- 4 A rectangular shaped position sign with a directional arrow to indicate motorist services adjacent to the road, or down a side road.

These signs are generally narrower than an equivalent chevron sign and should be used when space is restricted.

(b) SECOND NUMBER - NUMBER OF SYMBOLS

(c) LETTER SUFFIX - SIGN SIZE

A The smaller sign size which has a 60 mm symbol grid module, and

B The larger sign size which has an 80 mm symbol grid module.

The full range of motorist service signs, including their maximum dimensions, is shown in Table 8.6.

8.2.3 COLOUR

Motorist service signs have white borders, symbols and lettering on blue backgrounds.

Sign colours shall conform with the colour requirements of AS/NZS 1906.1 - 1993: *Retroreflective Materials and Devices for Road Traffic Control Purposes - Part 1: Retroreflective Materials*.

8.2.4 SHAPE

(a) ADVANCE SIGNS

Advance signs are rectangular in shape and usually have their long axis horizontal.

(b) POSITION SIGNS

Position signs normally have one end shaped as a point and have a chevron direction indicator.

Where space is restricted a narrower format rectangular type of sign, with an arrow direction indicator, may be used.

8.2.5 SIZE

Motorist service signs are detailed in two sizes, A and B. The appropriate sign size is determined by the following criteria:

- (a) **A** size signs should be used when:
- the speed of approaching vehicles is less than 70 km/h,
 - the sign is not affected by competing visual stimuli, and
 - the sign is not offset too far from a driver's normal line of sight.
- (b) **B** size signs should be used in all other situations.

8.2.6 MOTORIST SERVICE SYMBOLS

Only the symbols shown in Figure 8.21 may be used to indicate motorist services.

Motorist service symbols are identified by the prefix S and a number. The size of the rectangular symbol grid module is indicated by a letter suffix, eg. S6A.

The symbols are positioned on modular gridded rectangles. The grid module sizes are given in Table 8.1 and details of the modular gridded symbol rectangles, which have narrow, medium and wide configurations, are as follows:

- Narrow Configuration:** 4 modules wide × 5 modules high,
- Medium Configuration:** 5 modules wide × 5 modules high, and
- Wide Configuration:** 6 modules wide × 5 modules high.

TABLE 8.1: GRID MODULE SIZES FOR MOTORIST SERVICE SIGNS

Sign size	Grid module size (mm)
A	60
B	80

Details of the motorist service symbols and their modular gridded rectangles are given in Section 8.7, Figures 8.22 to 8.31.

8.2.7 LETTER STYLE AND SIZE

All lettering on motorist service signs must be in Series D or E CAPITALS with a medium letter spacing, ie. DM or EM. The lettering should never be less than 120 mm high on any motorist service sign and will normally be:

- 120 DM on A-size signs, and
- 160 DM on B-size signs.

8.2.8 DISTANCES

Distances must be shown in the following manner:

Distance	Increment	Shown as
Up to 500 metres	50 metre	"xx m"
Between 500 metres and 1 kilometre	100 metre	"xxx m"
1 kilometre or more	Nearest kilometre	"xx km"

8.2.9 BORDERS

Motorist service signs should have plain borders which extend to the edges of the signs.

Plain borders are generally 1.25 and not more than 1.50 times the stroke width of the largest letters used on the sign, rounded to the nearest 5 mm. For motorist service signs the border width should normally be:

- 25 mm, and not more than 30 mm for A-size signs, and
- 35 mm, and not more than 40 mm for B-size signs.

8.2.10 DESIGN VARIATIONS

Some variation in the design and/or layout of standard motorist service signs may be required to suit a modular design system, or to adjust signboard shape to fit a location with space restrictions. All modified sign layouts must however comply with the following sign design principles:

- The specified colour codings, standard traffic guidance legends and standard symbols must be used.
- Only the symbols shown in Figure 8.21, and detailed in Figures 8.22 to 8.31, may be used.
- The minimum lettering sizes specified for standard motorist service signs must be used.
- Message lengths must be compatible with the reading time available to drivers, at the prevailing traffic speed.
- All signs must be designed in accordance with the methods detailed in Section 8.6: *Sign Design and Layout*.

8.2.11 EXAMPLES OF MOTORIST SERVICE SIGNS



FIGURE 8.1: ADVANCE SIGNS FOR SERVICES ADJACENT TO THE ROAD

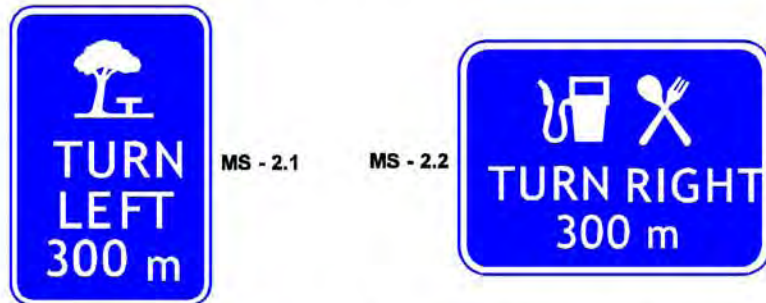

FIGURE 8.2: ADVANCE SIGNS FOR SERVICES ON A SIDE ROAD



FIGURE 8.3: POSITION SIGNS FOR A SINGLE SERVICE

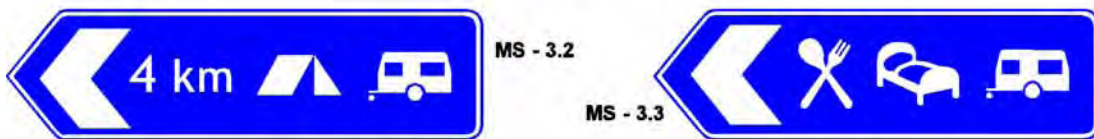

FIGURE 8.4: CHEVRON TYPE POSITION SIGNS FOR MULTIPLE SERVICES



FIGURE 8.5: A NARROW FORMAT POSITION SIGN FOR MULTIPLE SERVICES

8.3 SIGN PROVISION CONDITIONS

8.3.1 INTRODUCTION

This section of the Manual sets out the conditions that must be met before motorist service signs are provided.

Only those services defined in Section 8.1.3 (b) of this manual are recognised as motorist services.

Figure 8.6 is a flow chart for determining the signing requirements for a motorist service. It is a summary of the sign provision conditions given in Sections 8.3.2, 8.3.3 and 8.3.4 below.

8.3.2 GENERAL CONDITIONS FOR THE PROVISION OF MOTORIST SERVICE SIGNS

- (a) Motorist service signs must not be erected on the approaches to communities, to advertise services available in those communities.
- (b) Motorist service signs are not normally provided for commercial services in urban areas. However, in special situations where, for example, the entry to a service facility is located on a parallel service road or service area adjacent to the main road and the means of access is not readily apparent to a driver, a position sign may be required at the point where vehicles must turn off the main road.
- (c) Motorist service signs are not normally provided for commercial services in rural areas when the service is located adjacent to the road and:
- suitable advertising signing is or can be erected within its grounds, or
 - advertising signs are erected on private property in advance of the service facilities.
- (d) Except for the services noted in 8.3.2 (e): *Accommodation Services*, motorist service signs are not provided for services located a "reasonable distance" along side roads where:
- there is an equivalent service adjacent to the main road, and
 - that service is located a "reasonable distance" along the main road from the side road intersection.
- A "reasonable distance" in these situations is defined as:
- (i) Up to 2 km in urban areas.
 - (ii) Up to 5 km in rural areas.

(e) Accommodation Facilities

- (i) Generally, accommodation facilities, caravan parks and camping grounds located a "reasonable distance along a side road" may be indicated by motorist service signs. A "reasonable distance along a side road" in these situations is defined as:
 - up to 2 km in urban areas, and
 - up to 5 km in rural areas.
- (ii) In addition, lodges, caravan parks and camping grounds located between 5 and 50 km along a side road in a rural area may also be indicated by motorist service signs.

8.3.3 ADVANCE SIGNS

Advance signs are not normally required in urban areas and on low speed roads. Advertising signs at or within the grounds of service facilities should be sufficient in these situations. Advance signs may however be provided in the following situations:

- when services are located in urban fringe areas and the 85% traffic speeds past sites exceeds 75 km/h,
- when advertising and/or position signs at service facility locations do not provide adequate advance notice of them, i.e. signs are not visible to approaching drivers for sufficient time to allow the safe completion of any manoeuvres necessary to enter a service facility or to turn-off into a side road. This time is defined as "Approximately 10 seconds at the 85% speed of traffic on the road",
- if safety problems are likely to be caused by vehicles suddenly stopping, slowing down, changing lanes or turning near entrances or side road turn-offs to service facilities.

8.3.4 POSITION SIGNS

Position signs should only be provided at the turn-off to a side road when the service located on the side road warrants motorist service signing.

Position signs are not normally required for services adjacent to the road when:

- services are located in urban areas,
- services are located on low speed roads, i.e. 85% traffic speed is < 75 km/h,
- advance signs have been provided,
- advertising signs are erected on private property in advance of service facilities.

Signing within the grounds of the service facilities themselves should be sufficient to mark their locations for the last two situations described above.

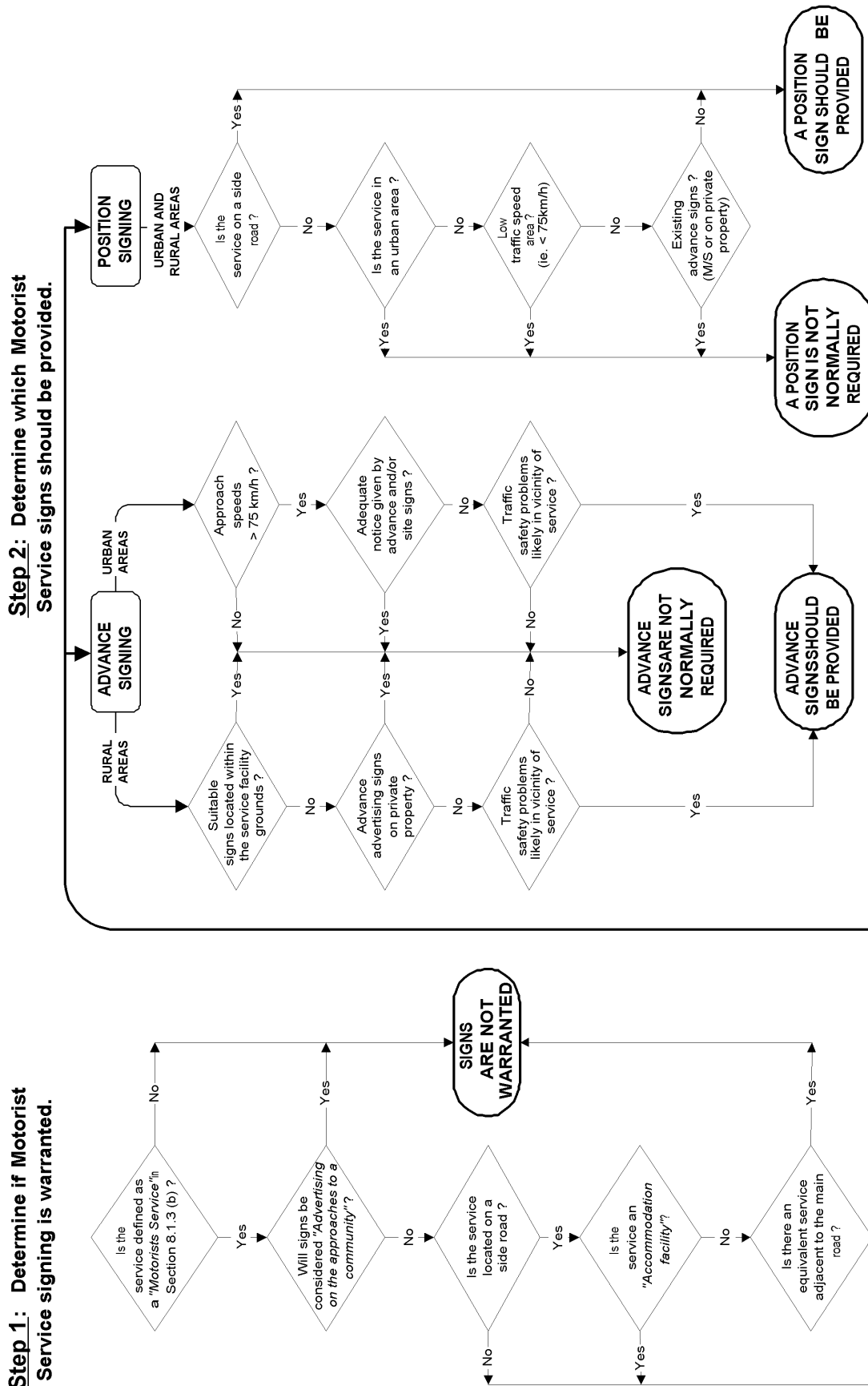

NOTE: The two step process indicated by the flowchart will ensure consistent and logical determination of the signing required for motorist services. The summarised text in flowchart boxes *MUST* be read in conjunction with the full motorist service sign provision and signing requirements contained in Sections 8.3 and 8.4 of this Manual.

FLOWCHART TO DETERMINE THE SIGNING REQUIRED FOR MOTORIST SERVICES

FIGURE 8.6

8.4 SIGNING REQUIREMENTS

8.4.1 ADVANCE SIGNS

When advance signs are required MS - 1 or MS - 2 signs should be used to advise travellers of the service(s) available on the road ahead.

Advance signs must show:

- the distance to the service(s) or the turn-off to a service(s) on a side road, and
- no more than four (4) symbols to indicate the services available.

NOTES:

1. *Most drivers are not able to read and comprehend more than four (4) symbols during the time a sign is within readable range.*
2. *The standard 300m distance may occasionally need to be varied when a sign cannot be located at this position. In these cases actual distance should be rounded to the nearest 50 metres.*

Examples of advance motorist services signs are illustrated in Figures 8.1 and 8.2.

8.4.2 POSITION SIGNS

(a) GENERAL

When position signs are necessary MS - 3 or MS - 4 signs should be used to indicate the actual location of, or side road turn-off to, the service.

A position sign must be located:

- at, or directly opposite, the point of entry to a service facility located adjacent to the main road, or
- in conjunction with the normal intersection direction signs at a side road turn-off when the service is located on a side road.

All services indicated on any advance signing must be repeated on the position sign(s).

(b) SIGN FORMAT

Position signs should normally conform to the MS - 3 sign layout, ie. a pointed end sign with a chevron direction indicator stripe.

The narrower format sign, ie. the MS - 4 sign layout, should be used when site conditions are restricted. An MS - 4 sign must have its direction arrow located:

- below the symbol(s) for 45° angled direction indications, or
- above the symbol(s) for straight ahead direction indications.

(c) SIDE ROADS

Position signs at side road turn-offs should have the distance shown when the service is located more than 1 kilometre along the side road. The distance is shown as "*n km*" and must be located between the symbol(s) and the chevron stripe or arrow directional indicator. Figure 8.4 illustrates a motorist service position sign (MS-3.2) with a distance indication.

Examples of position signs for motorist services are illustrated in Figures 8.3, 8.4 and 8.5.

8.4.3 COMBINED DIRECTION, MOTORIST SERVICE AND TOURIST SIGNS

When combined direction, motorist service and/or tourist signs are required they should be located in the following manner:

(a) ADVANCE SIGNS

Advance motorist service signs are located prior to advance direction signs.

When an advance tourist sign is also required it should be combined with the advance direction sign.

(b) POSITION SIGNS

Motorist service position signs are normally mounted immediately below intersection direction signs and on the same supports.

When a tourist position sign is also required the following layout should be used:

- the tourist position sign shall be mounted immediately below the intersection direction sign and on the same supports, and
- the motorist service position sign shall be located slightly in advance of the combined intersection direction/tourist position sign.

8.5 APPLICATION

8.5.1 REST AREAS

(a) GENERAL

A rest area is defined as a place where vehicles can safely stop clear of the roadway and where services such as picnic tables, toilets, water, etc. may also be available.

Rest areas are indicated by the S1 (Tree and table) symbol.

Other motorist services not normally associated with rest areas may also be available and they should be indicated by use of the appropriate symbols.

(b) SIGNS

Advance and position signs should normally be provided for rest areas. Typical signing for a rest area is illustrated in Figure 8.10.

A rest area located on a side road, and more than about 1 km from the turn-off, would not normally be signed unless:

- it has some feature of interest to tourists, eg. a scenic lookout, or
- there is an unusually long distance to the next rest area on the main road.

TABLE 8.2: SYMBOLS WHICH MAY BE USED ON REST AREA SIGNS

Symbols	Symbol number
Rest area	S1
Information	S10
Public toilets	S13
Truck/trailer parking area	S16

Note: In addition to the standard 300m advance signs, it is desirable to also provide advance signs at distances of 10 km, 5 km and 2 km from the rest area where these can be accommodated. These are especially necessary on routes where drivers are known to suffer from fatigue.



EXAMPLE OF POSITION SIGN FOR REST AREAS SUITABLE FOR USE BY HEAVY MOTOR VEHICLES. SYMBOL S13 SHOULD BE ADDED WHEN APPROPRIATE.



FIGURE 8.7. EXAMPLES OF ADVANCE SIGNS FOR REST AREAS ADJACENT TO THE ROAD



FIGURE 8.8. EXAMPLES OF ADVANCE SIGNS FOR REST AREAS LOCATED ON A SIDE ROAD



FIGURE 8.9. EXAMPLES OF POSITION SIGNS FOR REST AREAS

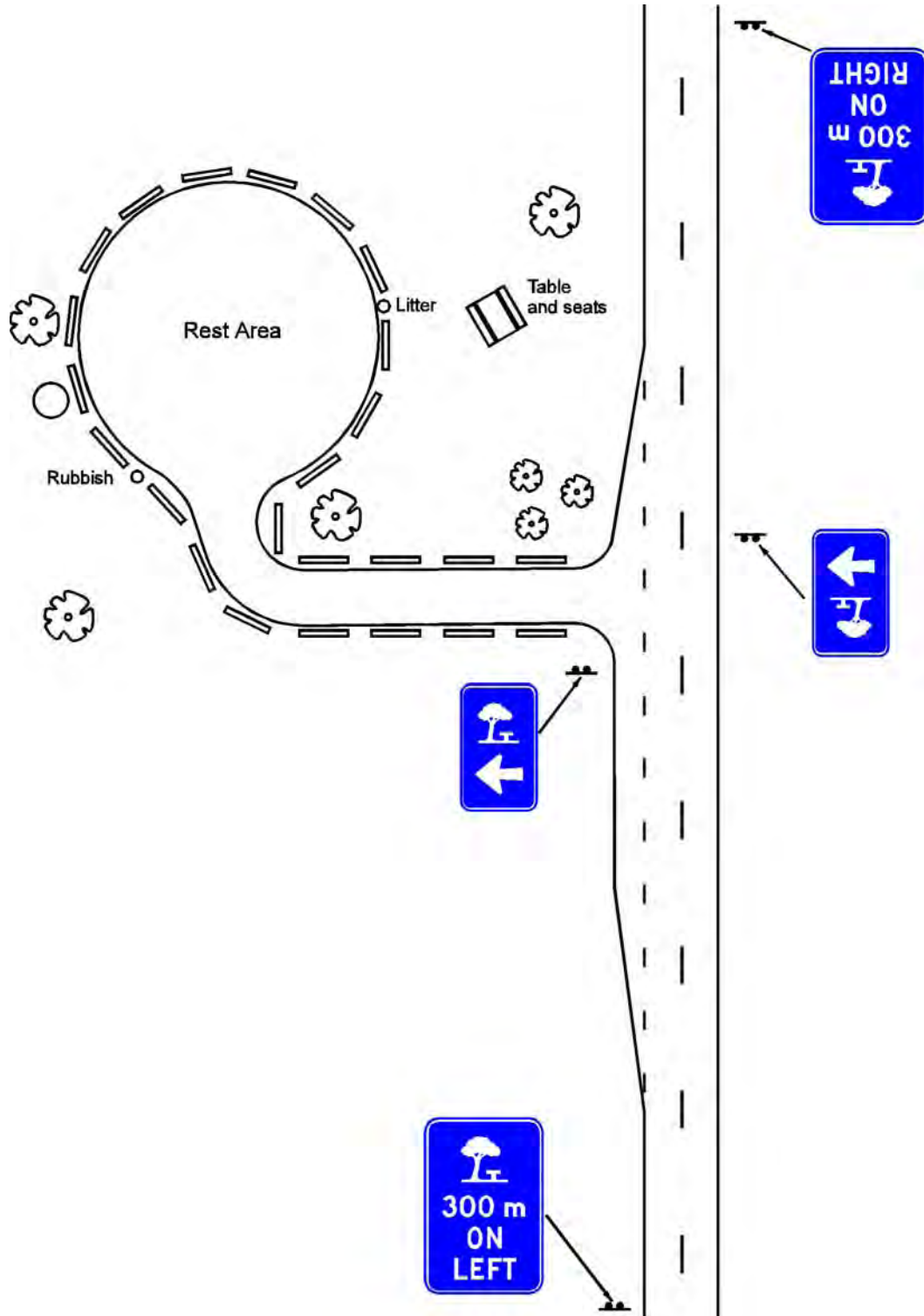

FIGURE 8.10

TYPICAL SIGNING FOR REST AREAS

March 2010

SECTION 8
MOTORIST SERVICE SIGNS:
APPLICATION

Rest Area
Suitable for
Left Turning
Heavy
Vehicles

"Next Rest Area Suitable for Heavy Vehicles" sign may be used when the next rest area suitable for heavy vehicles or town is greater than 50 km ahead.



"Rest Area 10 km" sign is desirable in areas where fatigue is known to be a concern.

"Next Rest Area" sign may be used when the next rest area or town is greater than about 50 km ahead.

Note:
Advance signs must not overlap with the next rest area or town.

Figure 8.10a

TYPICAL SIGNING FOR
REST AREAS SUITABLE
FOR TRUCKS

8.5.2 COMMERCIAL SERVICES

(a) GENERAL

The general conditions for the provision of motorist service signs are given in Section 8.3 of this Manual, *Sign Provision Conditions*.

TABLE 8.3: SYMBOLS WHICH MAY BE USED TO INDICATE COMMERCIAL SERVICES

Symbol	Symbol number
Motor fuel	S6
Motor fuel and repairs	S7
Refreshments	S8
Meals	S9
Public parking area	S15

Parking signs, with either the legend "PARKING", or the S15 symbol "P" may be used to indicate public parking areas operated on a commercial basis. Parking signs are not normally required to indicate that parking is available in the grounds of commercial services, signs within these facilities will usually indicate where to park.

(b) SERVICES NOT CONSIDERED TO BE COMMERCIAL SERVICES

For the purposes of motorist service signing Accommodation Services, Camping Grounds, Caravan Parks are not considered to be Commercial Services. Refer to Section 8.5.3 for details of signs that may be provided for Accommodation Services.

(c) COMMERCIAL SERVICES ADJACENT TO THE ROAD

Advance signs are not normally required for commercial services adjacent to two lane roads. They may however be necessary on divided roads and for some special situations when a position sign, or advertising signs within a site, are not readily visible to approaching drivers.

Position signs are also not normally required but they may be necessary on divided roads when a facility is located on the right hand side of a divided road and it is not readily visible to drivers. In these cases a position sign could be used to indicate:

- the median opening drivers should use, and/or
- the direction back to the service facility along the other carriageway or service road.

(d) COMMERCIAL SERVICES ON SIDE ROADS

Motorist service signs are not normally provided for commercial services on a side road unless there is no equivalent service adjacent to the main road within a "reasonable distance" and the service is located a "reasonable distance" along the side road.

Signs may be provided when a service complies with the "reasonable distance" conditions specified in Section 8.3.2 (d).

(e) SERVICE CENTRES

(i) Definition:

A service centre is defined as:

A purpose-built establishment catering mainly for the needs of road users which:

- has direct access from an adjacent high standard, preferably divided carriageway road, and
- contains, at least, individual services providing:
 - **Motor fuel** - a facility with all the features normally found at a large conventional service station, and
 - **Refreshments** - an "eat-in" cafeteria type facility serving tea, coffee, light meals, etc, and
 - **Public toilets** - a facility available to the general public, and
- has adequate parking, and
- is open 24 hrs a day, all days of the year.

(ii) Signing:

When a service centre is located in an area where the road has a posted speed limit of > 70 km/h and no similar services are available in the immediate area, any motorist service signing warranted for the facility may have the additional words "SERVICE CENTRE" added, **provided the operator(s) of the facility agree to pay all supply and erection costs associated with increasing the size of signs to accommodate the additional wording.**

NOTE:

The words "SERVICE CENTRE" shall only be added to normal or wide format signs. At restricted sites where a narrow sign format needs to be used there is usually insufficient sign width to accommodate the words on one line and the resultant sign would have a tall, unbalanced and visually unattractive layout.



FIGURE 8.11: TYPICAL ADVANCE SIGN FOR A SERVICE CENTRE

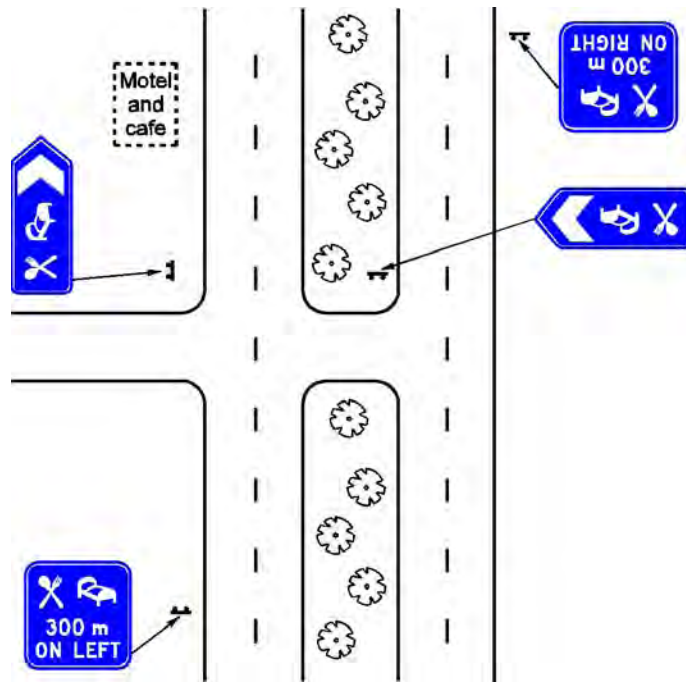

FIGURE 8.12: TYPICAL SIGNING FOR COMMERCIAL SERVICES ON A DIVIDED ROAD

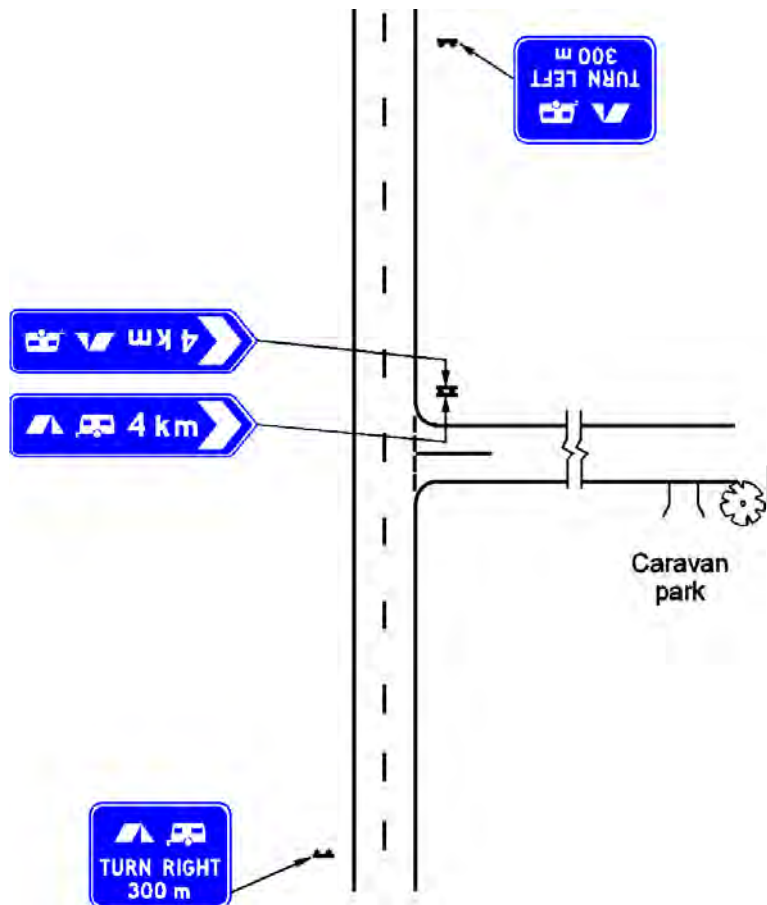

FIGURE 8.13: TYPICAL SIGNING FOR ACCOMMODATION SERVICES ON A SIDE ROAD



For dimensions refer to <http://www.landtransport.govt.nz/roads/tcd/sign-MS-motorist-service.html>

Policy: This sign consists of a PETROL STATION symbol with NEXT 'X' KM displayed on a standard motorist service sign plate.

These signs should be erected to advise travelers of the availability of petrol stations on the road ahead when the distance between petrol stations exceeds 100km, or as deemed necessary by the Road Controlling Authority.

Location: The sign should be located where approaching drivers have an uninterrupted view of it over a distance of at least 120 m in rural areas to at least 60 m in urban areas.

The sign should ideally be located at a suitable distance from the last petrol station so that road users can make an informed decision.

8.5.3 ACCOMMODATION SERVICES**(a) DEFINITION**

To qualify for signing as a motorist service an accommodation facility must:

- be available to casual travellers at all times, ie. all days of the year, and
- be a member of an appropriate operators association, eg. Lodge Association of New Zealand, HANZ, MANZ, HAPNZ, etc, and
- have written support from the regional tourist organisation. Preference will be given to facilities that have been rated by Qualmark.

(b) SIGNING

Accommodation facilities located a 'reasonable distance along a side road' may be signed. The S2 (Accommodation), S3 (Camping ground), S4 (Caravan park) and S5 (Camping ground and Caravan park) symbols may be used to indicate these types of facility. A 'reasonable distance along a side road' is defined in to Section 8.3.2 (e).

Where an accommodation facility is not located on, or adjacent to, the side road main road signing will not be approved until the side road controlling authority confirms, in writing, that they will provide all the additional signing that is required on the side road(s)

(c) WORD DESCRIPTORS

Word descriptors may be used to indicate the type or name of accommodation facility indicated by an S2 symbol in the following situations:

(i) Signs for a lodge, caravan park or camping ground located between 5 and 50 km along a side road in a rural area may have a word descriptor, **or the name of the facility**, eg. REMOTE AREA MOT OR CAMP, CASSIMIR LODGE, etc, shown in addition to the S2 symbol. The distance to the facility must also be shown on position sign(s).

(ii) In all other situations:

- signs displaying several motorist service symbols, one of which is an S2 symbol, may have a single word descriptor positioned immediately below that symbol, and
- signs displaying only the S2 symbol, ie. a single service sign, may have:
 - a single word descriptor positioned beneath the S2 symbol, or
 - up to three (3) word descriptors positioned alongside the S2 symbol, when there is more than one type of accommodation facility available, and
 - no word descriptors where there are more than three (3) different types of accommodation facilities available, ie. only the S2 accommodation symbol shall be displayed.

Word/name descriptors shall be shown in Series D CAPITAL lettering of an appropriate size.

Examples of word descriptors are: LODGE(S), HOTEL(S), MOTEL(S), CABIN(S), GUEST HOUSE, HOSTEL, YWCA, BACKPACKER, BED AND BREAKFAST (or B & B), HOME AND FARM HOST, etc.

8.5.4 INFORMATION SERVICES**(a) GENERAL**

Motorist service signs may be used to indicate facilities which provide local area information likely to be of interest to travellers on the road. These facilities may be either unattended or attended.

Unattended information facilities typically are:

- information bays, and
- information boards, town/district maps, etc, erected in rest areas.

Attended information facilities are where local and tourist information may be obtained or perused on the premises. The information available should include:

- oral advice,
- brochures, and
- maps, etc.

(b) UNATTENDED INFORMATION FACILITIES:

An unattended information facility is usually an information bay located on the approaches to a town or major tourist attraction. They are often used to indicate:

- the services available in the town, and
- features of interest in the region.

The primary display in an information bay should be a large map or diagram of the town/region which may also include panels advertising the availability of:

- food,
- accommodation, and
- other services likely to be useful to travellers.

(c) ATTENDED INFORMATION FACILITIES

Attended information facilities may be signed when they are located adjacent to the road, or a reasonable distance along a side road'. For signing information facilities a 'reasonable distance along a side road' is defined as:

- 500 m from the main road intersection in an urban area, and
- 2 km in a rural area.

Attended information facilities are either:

- Visitor Information Network (VIN) i-SITE's, or
- officially recognised facilities that provide the features described in Section 8.5.4 (a) above, and which:
 - operate in a manner appropriate for most travellers needs, and
 - are open at all reasonably expected times, ie. 9.00 am to 5.00 pm all days of the year.

In remote areas an attended information facility could be a subsidiary counter in a shop, service station or similar commercial activity. A much larger, single purpose, facility would, however, be expected in high activity tourist areas and resorts.

(d) SIGNING

(i) General

The general conditions for the provision of motorist service signs are given in Section 8.3: *Sign Provision Conditions*.

Information services are identified by the S10 'Information' symbol. This symbol must only be used to indicate officially recognised information service facilities.

Both advance and position signs are normally required for information service facilities.

Examples of typical advance and position signs for information service facilities are illustrated in Figures 8.14 (a) and (b).

Typical signing lay outs for information service facilities are illustrated in Figures 8.15 and 8.16.

(ii) Word Descriptors

Except for *i*-SITE's, New Zealand's official Visitor Information Network, a word descriptor should not be used on signs to indicate information service facilities.

However, when it is considered that the type of information facility will not be obvious to travellers on the road one of the following word descriptors may be used:

- CENTRE,
- BAY, and
- MAP.

(iii) Visitor Information Network (VIN) *i*-SITE's

Advance signs for *i*-SITE's shall use the standard motorist service sign format and colour scheme and may display the word descriptor '*i*-SITE', as shown on the typical sign illustrated in Figure 8.14 (b) on the right.

Position signs for *i*-SITE's may use the VIN *i*-SITE sign format and colour scheme illustrated in Figure 8.14 (a) below.

(iv) Parking Symbols

Parking symbols should not normally be shown on signs indicating motorist information facilities because signing within the facility itself will normally indicate where to park.

Parking areas within an information service facility may be indicated by the use of an S14 Parking symbol on a MS-4.1 position sign, when necessary.



MS - 1.1



MS - 1.2



MS - 2.1

FIGURE 8.14 (b): EXAMPLES OF ADVANCE SIGNS FOR INFORMATION SERVICES



Standard MS - 3.1
Position Sign



VIN *i*-SITE
Position Sign

FIGURE 8.14 (a): EXAMPLES OF POSITION SIGNS FOR INFORMATION SERVICES

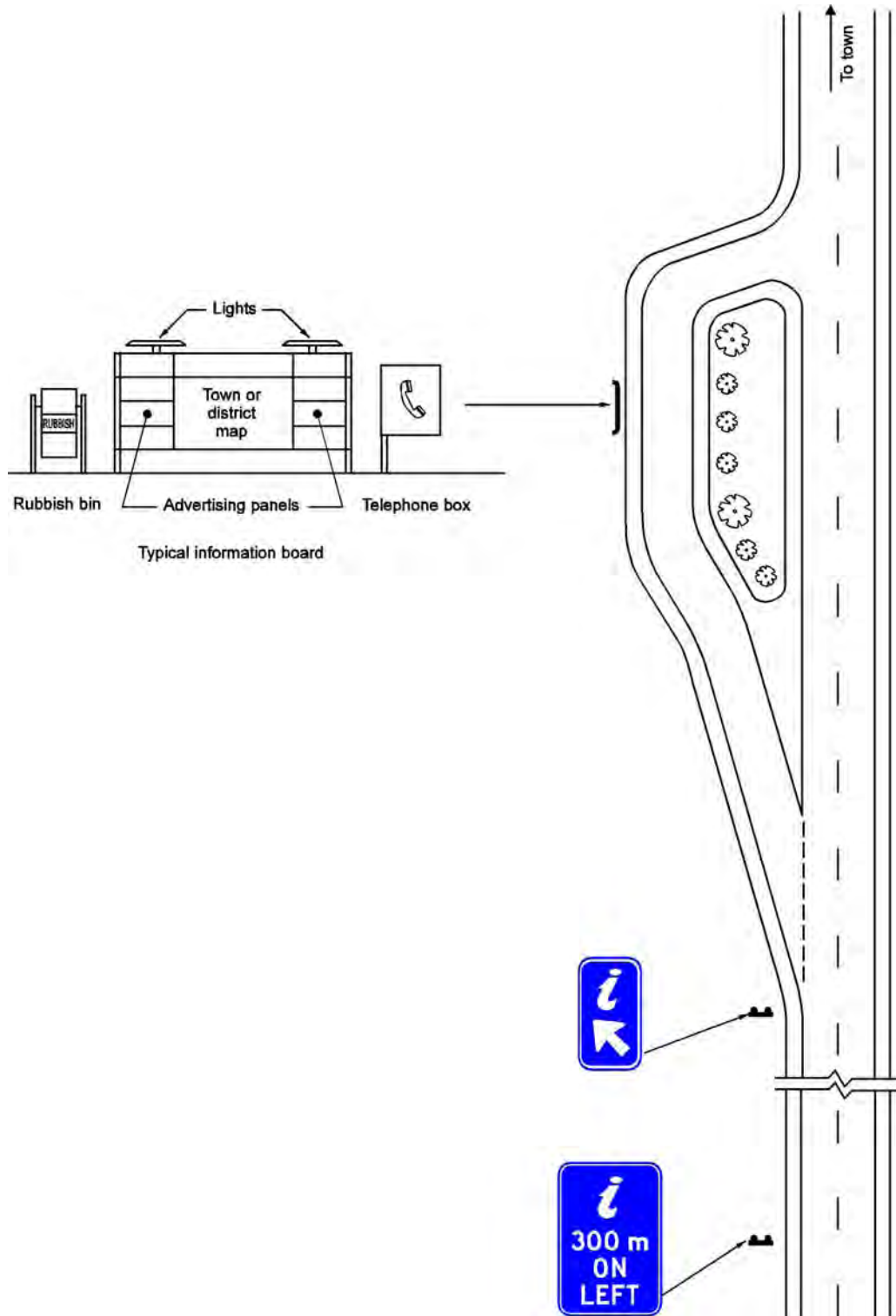

TYPICAL SIGNING FOR
UNATTENDED INFORMATION FACILITIES

FIGURE 8.15

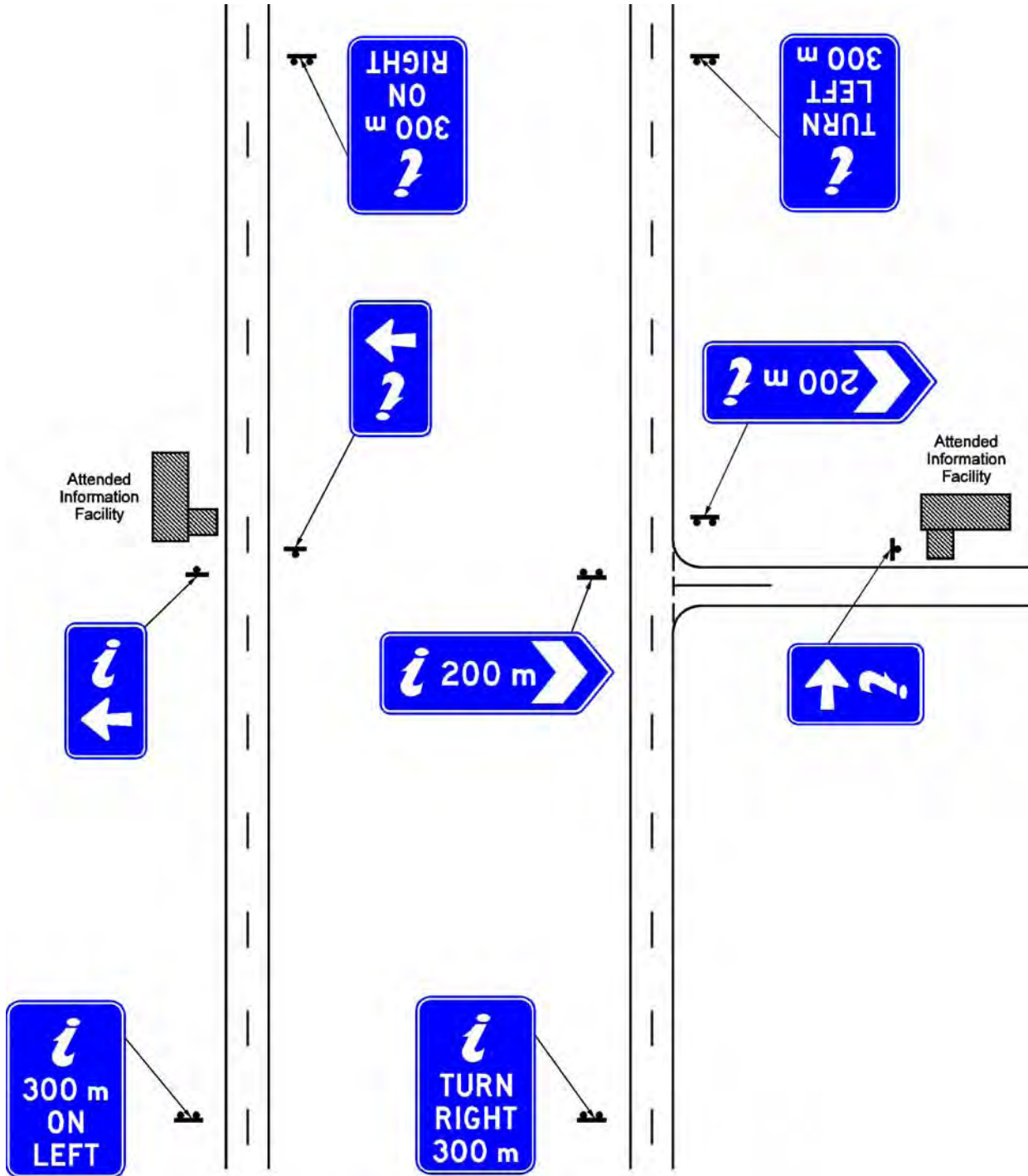

(a) Adjacent to the Road

(b) On a Side Road

FIGURE 8.16 TYPICAL SIGNING FOR ATTENDED INFORMATION FACILITIES

8.5.5 OTHER SERVICES

(a) DEFINITION

Other Services are defined as those local community services and facilities which are likely to be useful to travellers and can be indicated by symbols on motorist service signs.

These services are listed in Table 8.4 below.

TABLE 8.4: LOCAL SERVICES WHICH MAY BE INDICATED BY SYMBOLS ON MOTORIST SERVICE SIGNS

Symbol	Symbol number
Emergency medical services BUT only when available on a 24 hour basis	S11
Public telephone	S12
Public toilets	S13, S20
Public parking area	S15, S15-1, S15-2, S15-3
Truck/trailer parking area	S16, S17
Airfield	S18
Boat ramp	S19

(b) SIGNING RESTRICTIONS

Local community services and facilities which do not qualify as motorist services should normally be indicated by signs in the IG series. These signs are detailed in Section 10 of this Manual: *General Information Signs*.

NOTE: *Shopping centres on side roads are not to be indicated by motorist service signs. They should be treated as destinations on guide signs, in a manner similar to that used for signing bypassed communities. Refer to Section 8.5.6 for details of signing for bypassed communities.*

(c) SIGN FORMAT

Symbols are used to indicate other local services and facilities on motorist service signs. A word descriptor, in at least 90 DM CAPITALS lettering, may occasionally be used immediately beneath some motorist service symbols to further identify a particular type of service or facility.

(d) SIGNING

The general conditions for the provision of motorist service signs are given in Section 8.3 of this Manual, *Sign Provision Conditions*.

Advance signs are not normally provided for local community services and facilities in urban areas unless the time available for viewing a position sign is inadequate because of the prevailing road or traffic conditions at the site.

(e) APPLICATIONS

Guidelines for signing the most commonly available local community services are:

(i) Emergency medical services

The S11 symbol should only be used to indicate services providing 24 hour medical treatment.

Signs displaying an S11 symbol may include appropriate wording to show the type of service, eg. AMBULANCE, HOSPITAL, etc.

The hospital name may also be included if there is more than one hospital in the area.

(ii) Public telephones

Signs displaying S12 symbols may be erected when a telephone is:

- available for public use 24 hours a day,
- not readily visible from the road, or
- located on a side road and not more than:
 - 500 m from the main road intersection in an urban area, or
 - 2 km in a rural area.

The distance to the telephone should be shown in these situations.

(iii) Public toilets

All public toilets should be signed, even when they are not available on a 24 hour basis.

Where facilities for the disabled are available an S20 Wheelchair symbol should also be shown.

(iv) Public parking

Parking facilities which are either free or charge a fee may be signed, provided they are available for general public use.

Parking signs may also be used to show the direction to nearby parking facilities.

(v) Park and ride facilities

Signs to direct motorists to park and ride facilities should contain:

- an S15 Parking symbol,
- the appropriate transportation symbol, ie. S15-1, S15-2 or S15-3, and
- a direction arrow or a word message.



FIGURE 8.17: PARK AND RIDE SIGN SYMBOLS

The location of the facility, ie. suburb name, may also be shown and positioned immediately beneath the S15 parking symbol.

The words "Park and Ride" may be incorporated into the legend of signs at the entry points to these facilities.

(vi) Airfields

Major airports should be shown as destinations on guide signs, ie. they should form part of the legend on advance and intersection direction signs on the route to the airport.

The S18 Airfield symbol may be used on motorist service signs to:

- indicate side road turn-offs, or the entry point, to minor airports and flying fields, and
- indicate the route to an airport on airport route markers, when the airport is not a destination indicated on normal guide signing.

(vii) Airport routes

The signing of airport routes can be considered as similar to Tourist Route signing.

The start of an airport route should be indicated with a white on blue T R - 6 type sign in the following format:



Single service MS - 3 or MS - 4 signs displaying the S18 symbol should be used as route markers at all appropriate locations along the route. The orientation of the S18 symbol and the chevron or arrow should indicate the direction to be followed.

8.5.6 SERVICES IN BYPASSED COMMUNITIES**(a) GENERAL**

Where main roads pass relatively close to communities offering motorist services, and similar services are not available adjacent to the main road in that vicinity, the communities and the services available may be signed.

Local authorities should be consulted to determine which of the standard service symbols should be shown on the signs.

The number of symbols shall be kept to a minimum and no more than four (4) symbols shall be shown on any motorist service sign.

To warrant inclusion, services must be available at all reasonably expected times.

(b) SIGNING

When a main road passes through a town or city, but not through the town or city centre, an intersection direction sign showing the destination "Town/ City Centre" is usually sufficient to indicate the provision of normal motorist services.

When there is doubt that the normal motorist services will be available in a bypassed community, motorist service signing may be provided, in conjunction with the normal guide signing.

The general conditions for the provision of motorist service signs are given in Section 8.3 *Sign Provision Conditions*.

When direction and motorist service signs are required they shall be provided in accordance with Section 8.4.3 *Combined Direction, Motorist Service and Tourist Signs*.

FIGURE 8.18 illustrates typical signing for motorist services in a bypassed community.

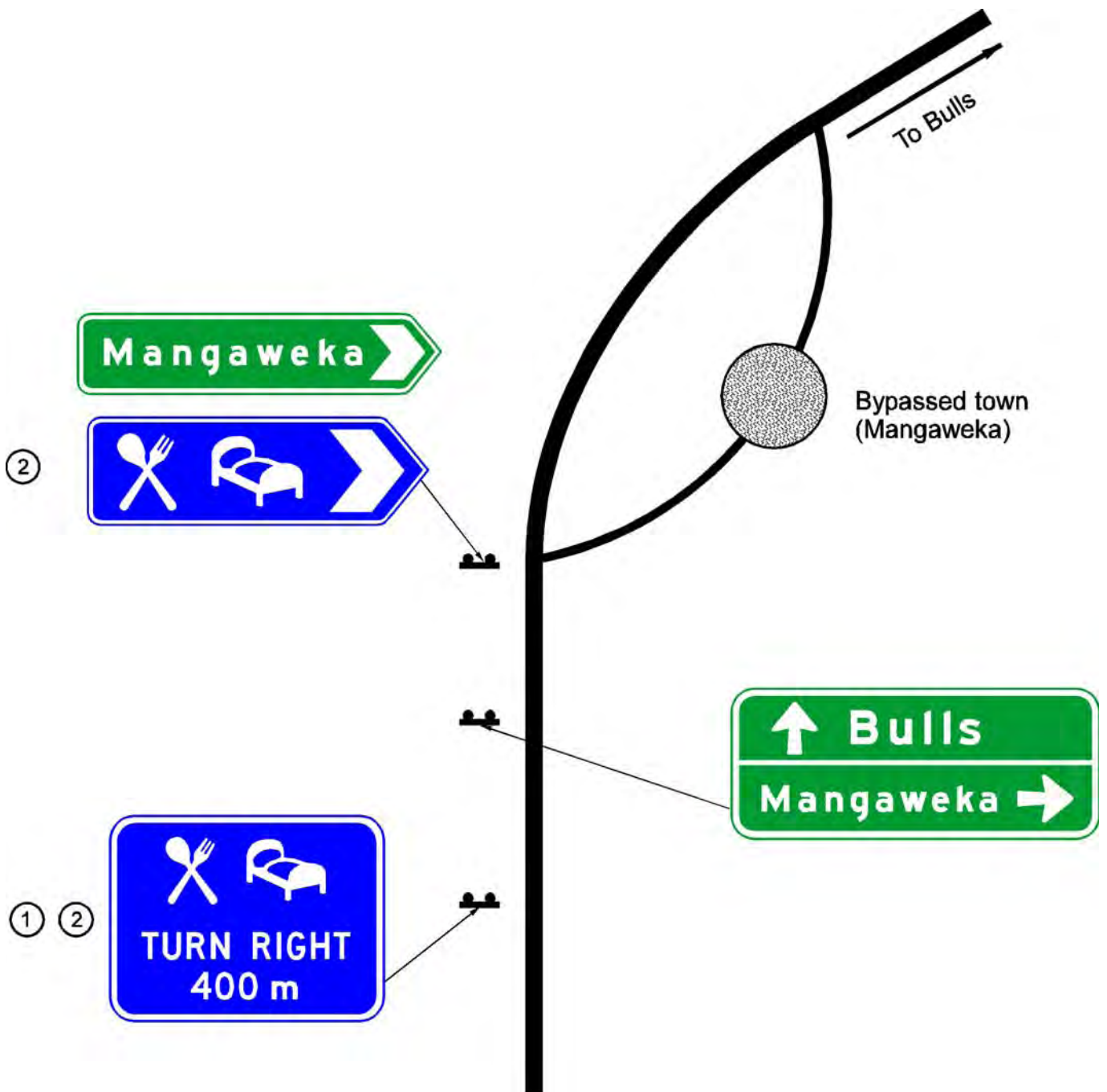

- NOTES: 1. The city, town or community name may be included on this sign, if desired.
2. Signs should be provided only when:
- the services are not available adjacent to the main road, and
 - there is doubt that normal motorist services will be available in the bypassed community.

8.6 SIGN DESIGN AND LAYOUT

8.6.1 INTRODUCTION

This section details the method recommended for determining the size and layout of motorist service signs in the MS sign Series.

Motorist service sign details are specified in Section 8.2: *Sign Details*.

8.6.2 SYMBOLS

Motorist service symbols are detailed in Figures 8.22 to 8.31. The symbols have been positioned and sized within their rectangles so that signs can be made up by allowing a clearance of one grid module between:

- adjacent rectangles,
- rows of rectangles,
- rectangles and text legends, borders, etc, and
- rows of text legends, borders, etc.

Examples of symbol layouts are shown on the typical motorist service signs illustrated in Figures 8.32 to 8.37.

8.6.3 SIGN DESIGN PROCEDURE

The recommended design procedure for motorist service signs is:

- Establish the sign size, ie. **A** or **B**, using the selection criteria defined in Section 8.2.5,
- Determine the appropriate grid module size from Table 8.1, and
- Determine the width and height of the sign using the method detailed in Sections 8.6.4 or 8.6.5 below.

8.6.4 RECTANGULAR SIGN DESIGN

A typical rectangular type motorist service sign is shown in Figure 8.19. This sign is used to illustrate the rectangular sign design procedure which is as follows:

- (a) Allow a horizontal separation of one grid module between symbols regardless of whether the row of symbols or the text legend determines sign width.
- (b) Determine dimensions x_1 and x_2 , the lengths of the rows of symbols by:
 - (i) summing the number of horizontal grid modules in each symbol rectangle,
 - (ii) adding one grid module for each space between symbols, and
 - (iii) multiplying by the grid module size selected.

Using an A-size grid module the calculation for x_2 in Figure 8.19 is:

$$(6 + 6 + 1) \times 60 = 780 \text{ mm.}$$

- (c) Determine W , the overall width of the sign, by adding the x dimension and the two y edge distances, where:
 - (i) x is the larger of:
 - x_1 or x_2 , the lengths of the symbol rows, or
 - x_3 , the length of the legend below the symbol, and
 - (ii) y is one grid module plus the border width.

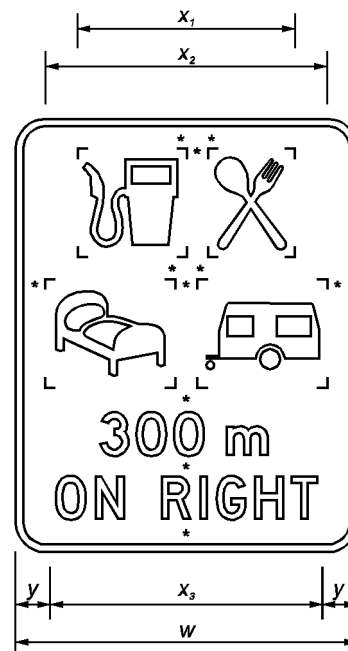

NOTE: * Indicates a clearance of one grid module.

FIGURE 8.19: A TYPICAL RECTANGULAR SIGN LAYOUT

- (d) Sign height is determined by allowing a vertical separation of one grid module between:
 - (i) Rows of symbols,
 - (ii) Rows of symbols and a line of text legend,
 - (iii) Lines of text legend, and
 - (iv) Rows of symbols or a line of text legend and a border, and then summing:
 - the heights of the rows of symbols,
 - the heights of the lines of text legend,
 - all vertical separation heights, and
 - the border widths.

(e) To give a convenient manufacturing size the clearances between symbols and borders may then be:

- decreased to a minimum of 0.5 times the size of the grid module, or
- increased to a maximum of 1.25 times the size of the grid module.

8.6.5 CHEVRON SIGN DESIGN

A typical chevron type motorist service sign is shown in Figure 8.20. This sign has been used to illustrate the chevron sign design procedure, which is as follows:

(a) W , the overall width of the sign, is the sum of dimension x , dimension y_1 and dimension y_2 , where:

- (i) x is the length of the row of symbols and is determined by:
- summing the number of horizontal grid modules in each symbol rectangle,
 - adding one grid module for each space between symbols, and
 - multiplying by the appropriate grid module size.

(ii) y_1 , y_2 and sign height h are standard dimensions for chevron type signs and are given in Table 8.5.

TABLE 8.5: STANDARD DIMENSIONS FOR CHEVRON TYPE SIGNS (mm)

A size signs	y_1	462
	y_2	85
	h	470
B size signs	y_1	619
	y_2	115
	h	630

(b) To give a convenient sign manufacturing size the normal clearance of one grid module included in the standard dimensions given in Table 8.5 above may be:



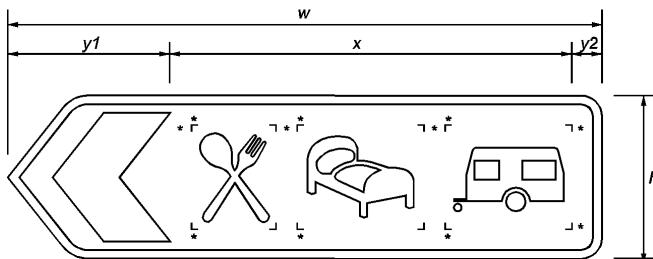

















- decreased to a minimum of 0.5 times the size of the grid module, or
- increased to a maximum of 1.25 times the size of the grid module.



NOTE: * indicates a clearance of one grid module.

FIGURE 8.20: A TYPICAL CHEVRON SIGN LAYOUT

8.7 MOTORIST SERVICE SYMBOLS

No.	Symbol	No.	Symbol	No.	Symbol
S1	 Rest Area	S8	 Refreshments: <i>Light meals, Cafeterias, etc.</i>	S15	 Public Parking Area
S2	 Accommodation: <i>Lodge(s), Hotel(s), Motel(s), Guesthouse, etc.</i>	S9	 Meals: <i>Restaurants, Licensed Restaurants, etc.</i>	S16	 Truck Parking Area
S3	 Camping Ground	S10	 Information	S17	 Truck Trailer Parking Area
S4	 Caravan park*	S11	 24 hour emergency medical service	S18	 Airfield
S5	 Camping Ground and Caravan Park	S12	 Public Telephone	S19	 Boat Ramp
S6	 Motor Fuel: <i>Petrol, Diesel, LPG and CNG</i>	S13	 Public Toilets	S20	 Wheelchair Access
S7	 Motor Fuel and Repairs	S14	 Waste Disposal Point (<i>Campervans and caravans only</i>)		

* See also symbol S4a on page 8-24a

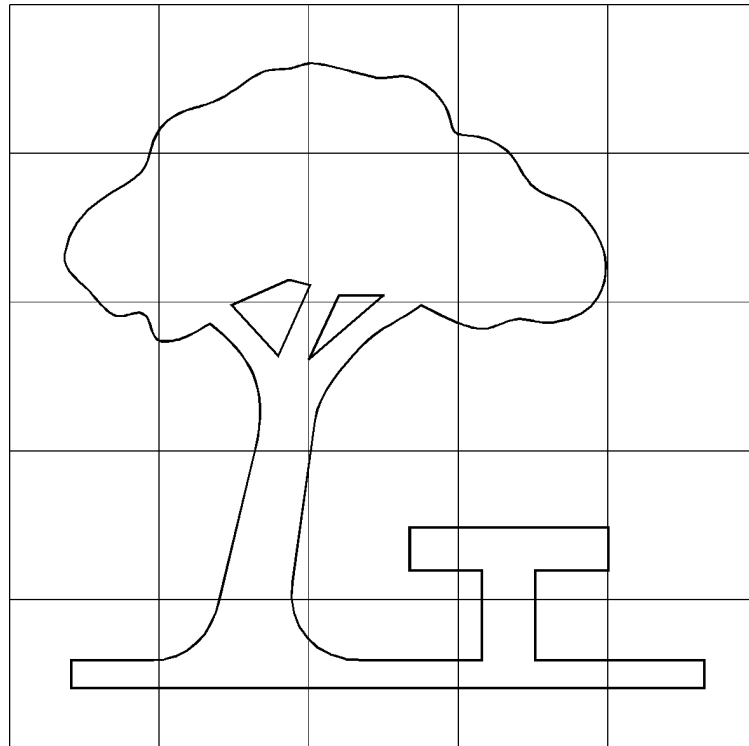

S1

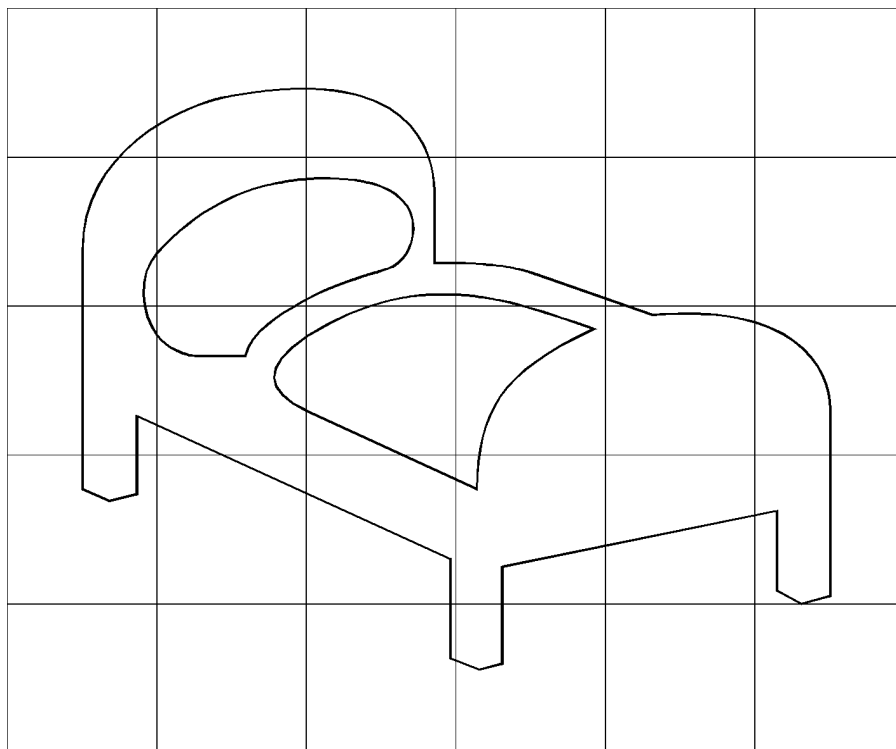

S2

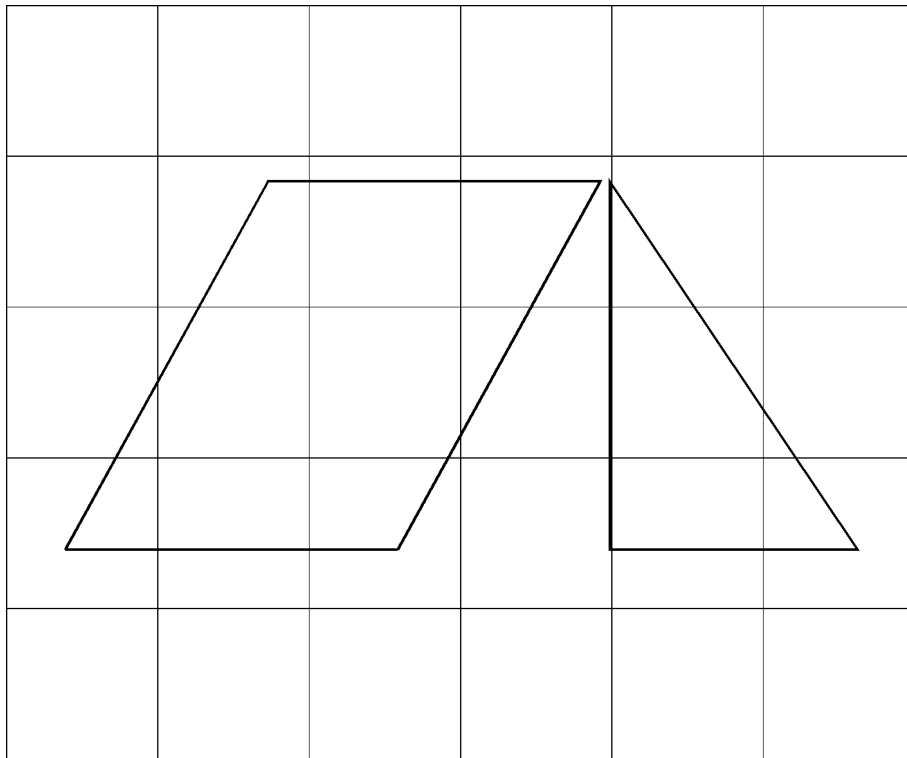

S3

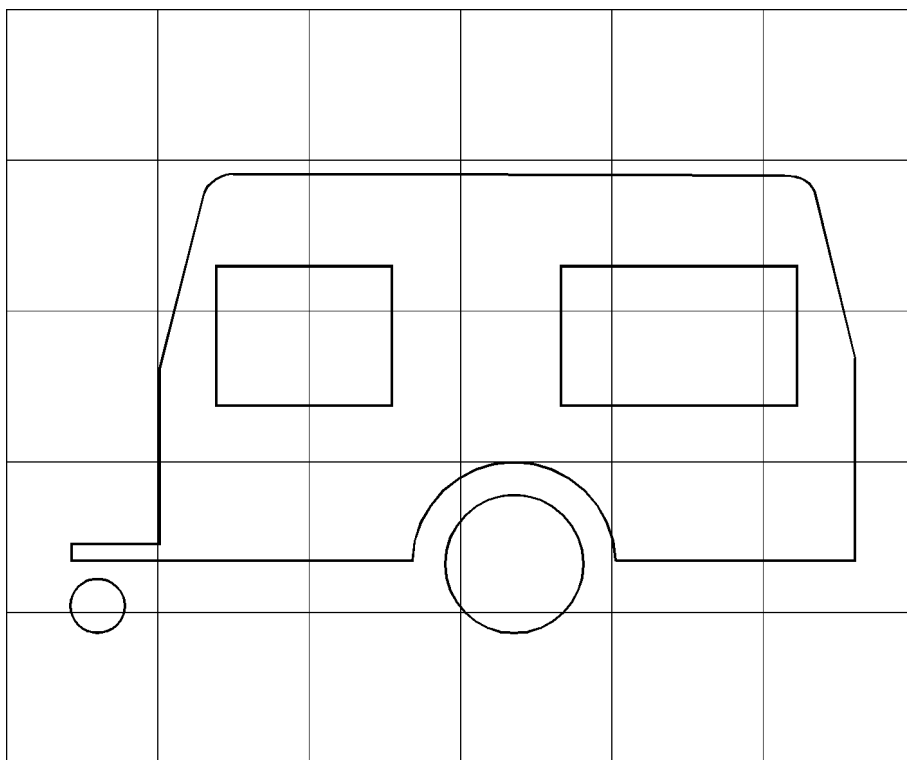

S4

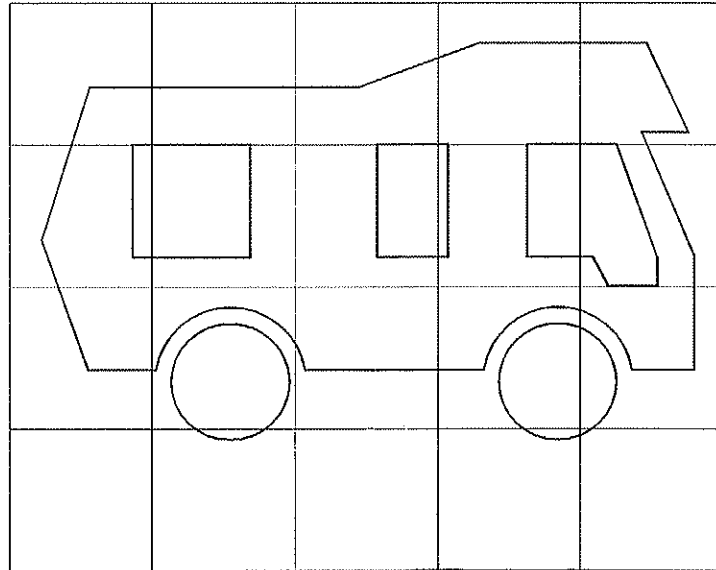

S 4a

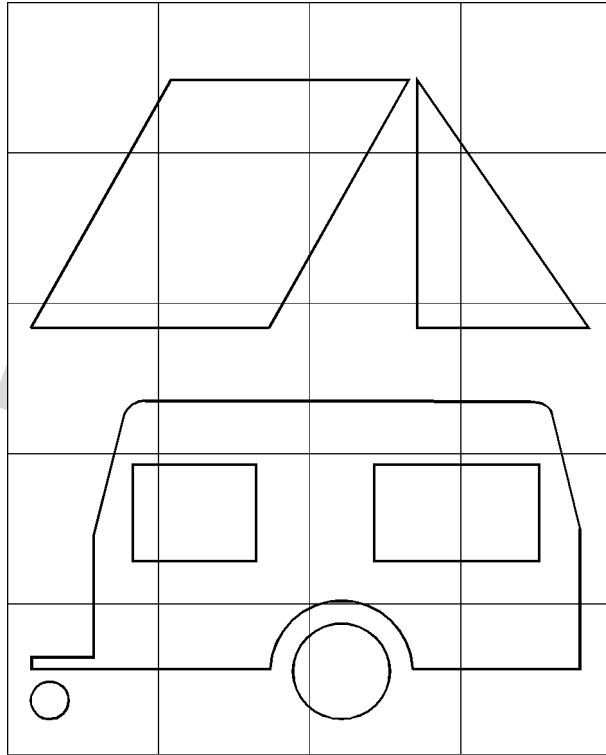

S5

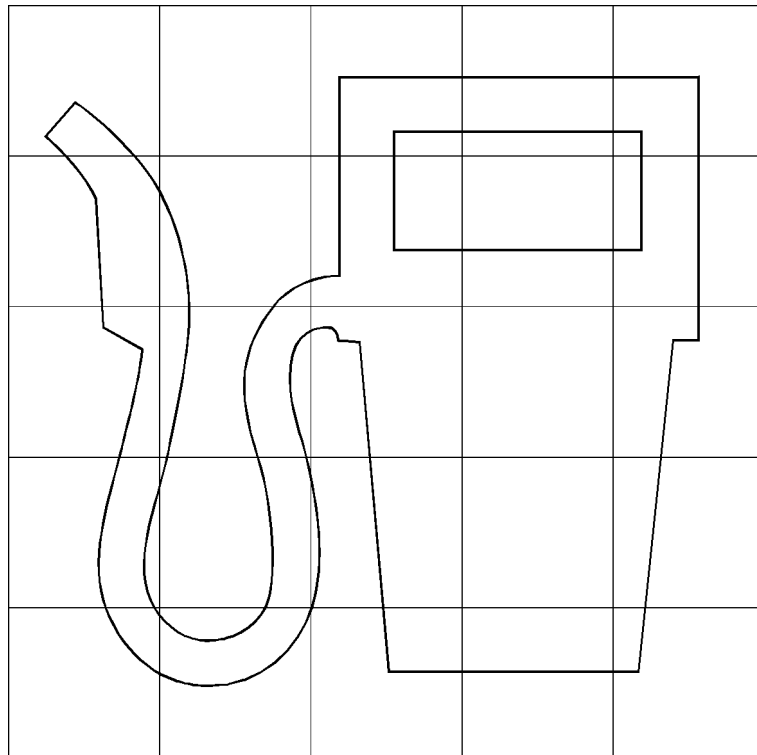

S6

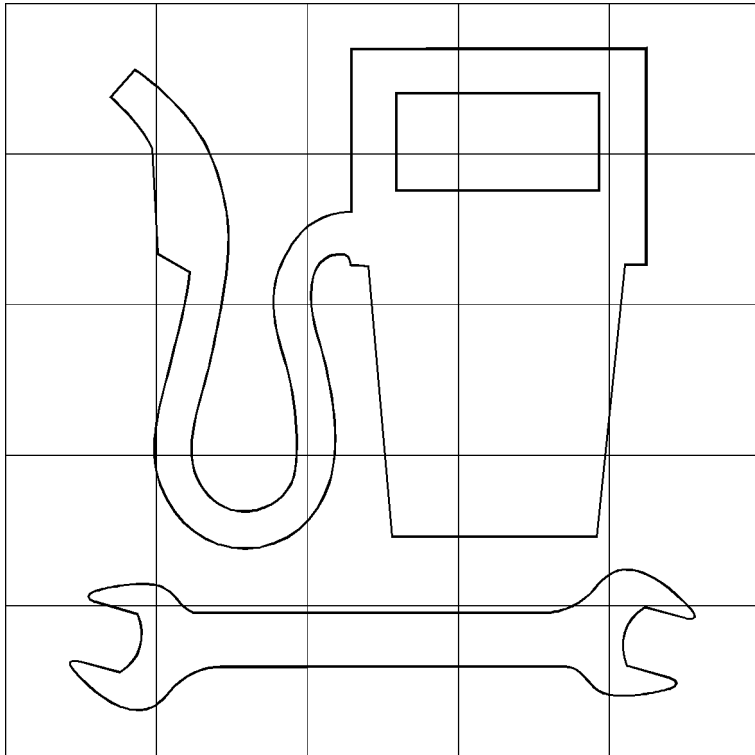

S7

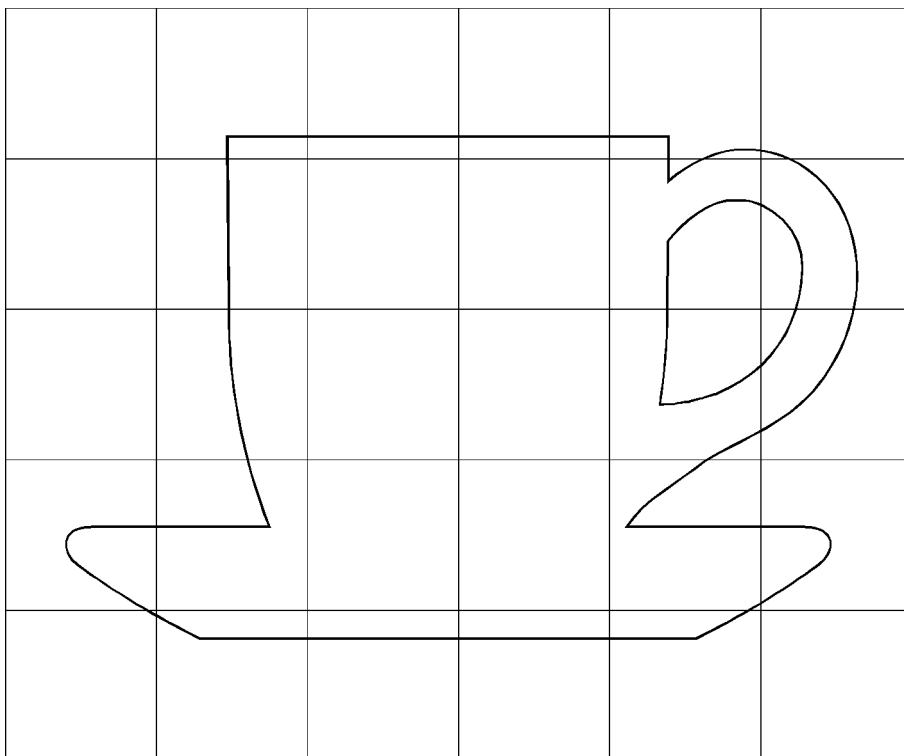

S8

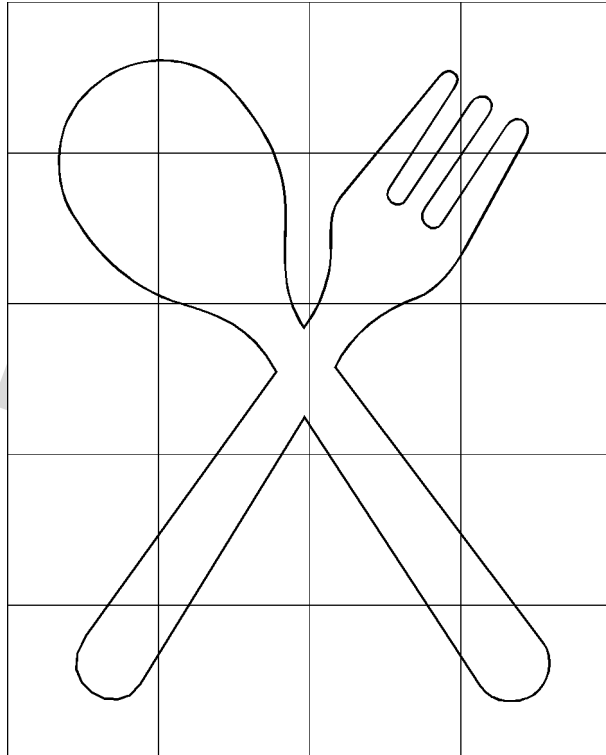

S9

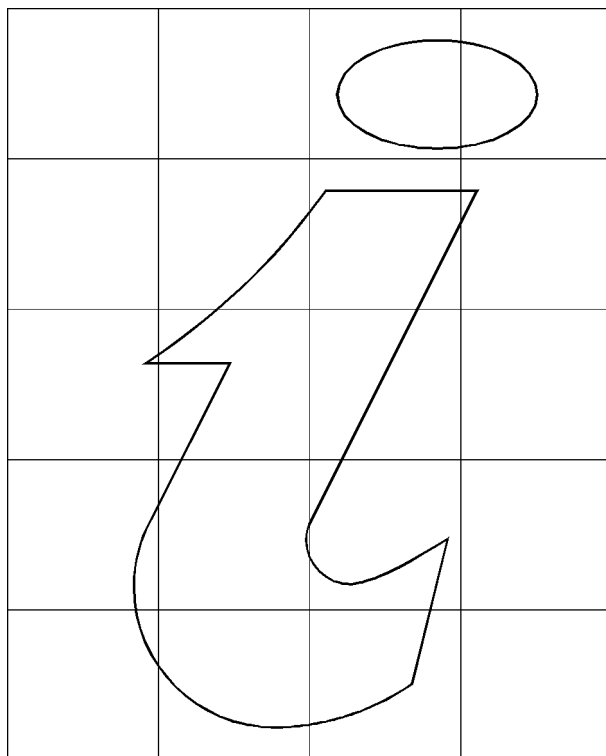

S10

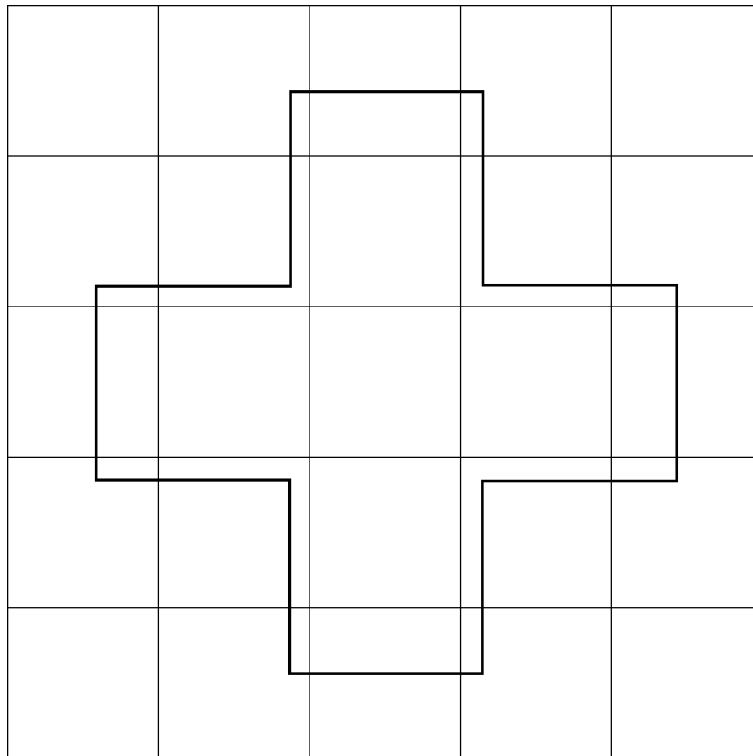

S11

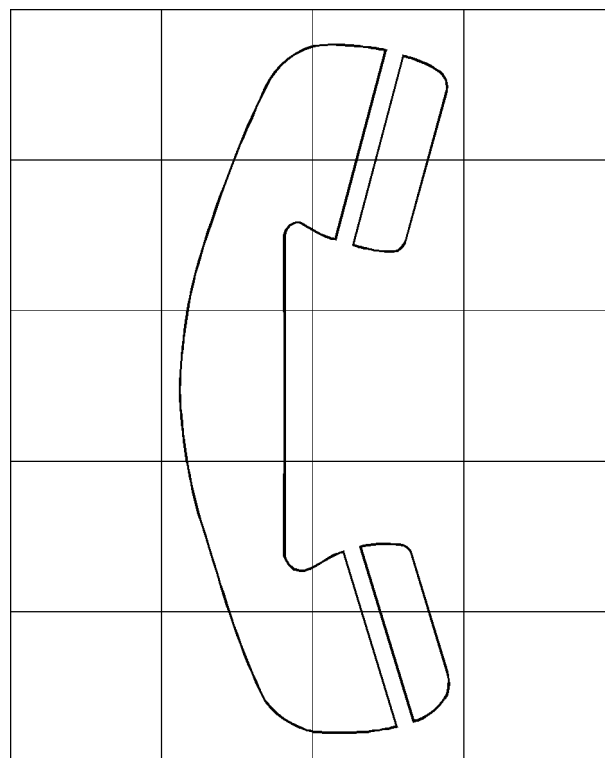

S12

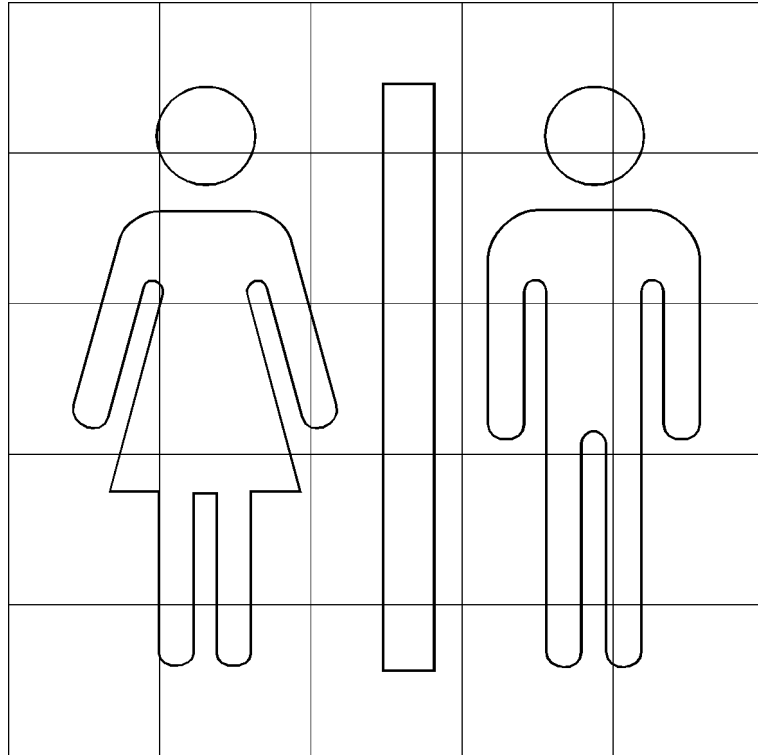

S13

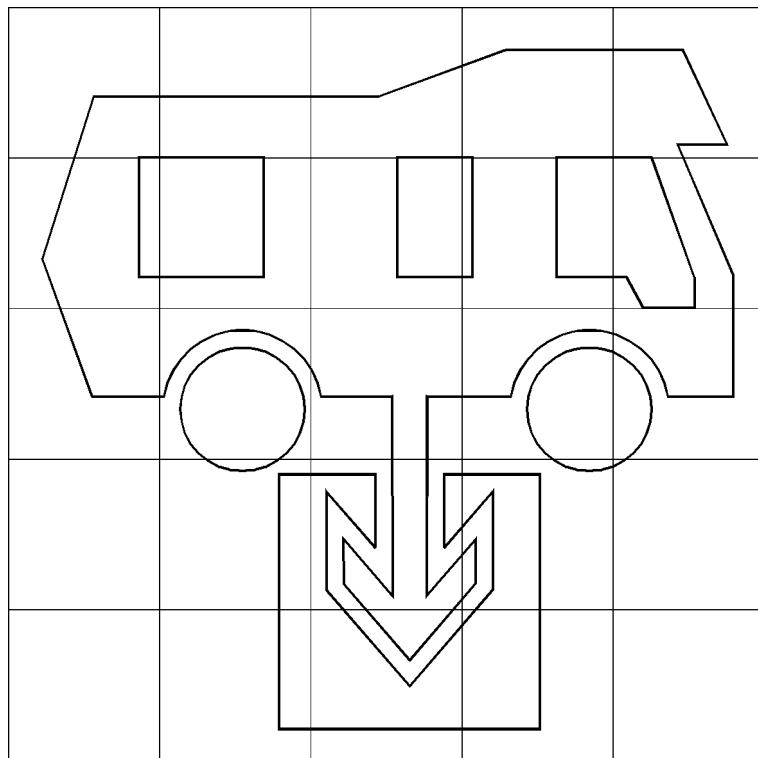

S14

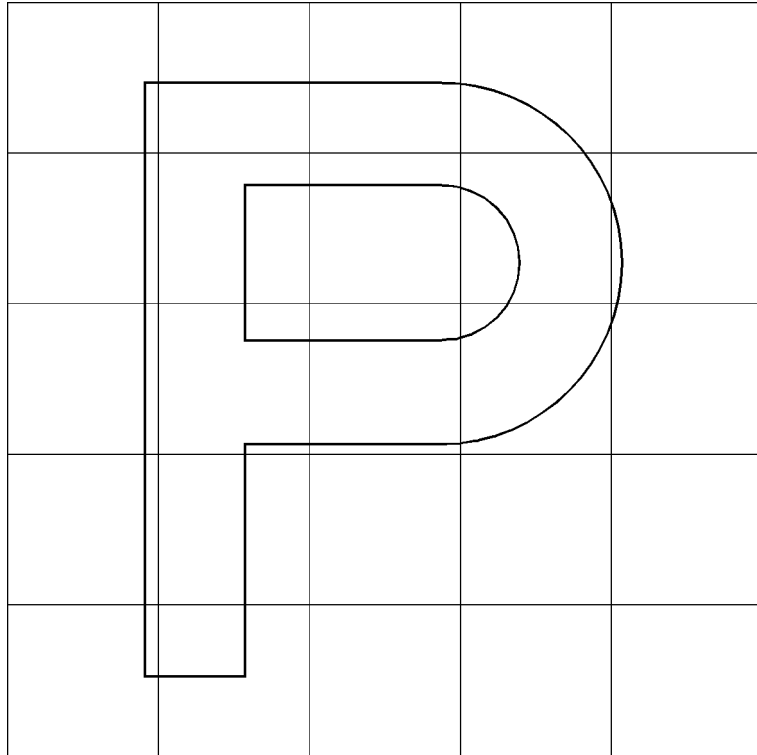

S15

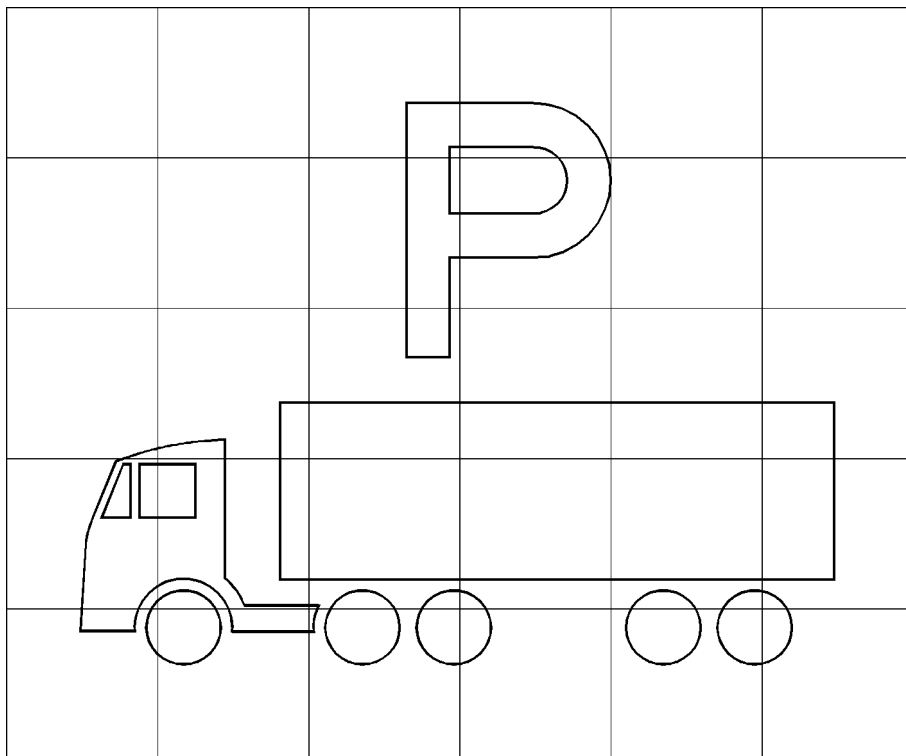

S16

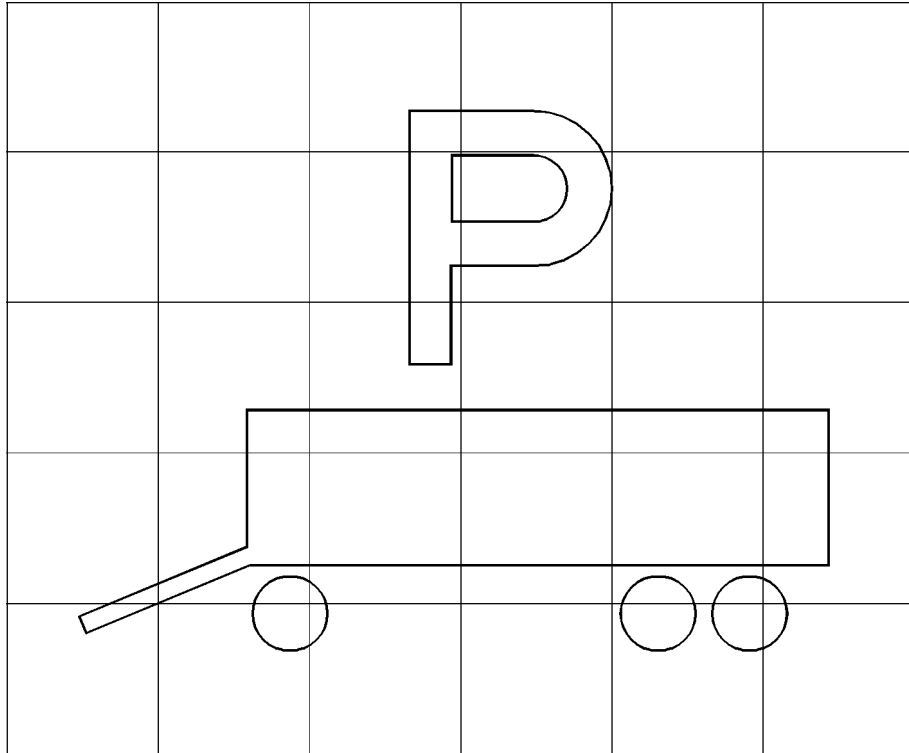

S17

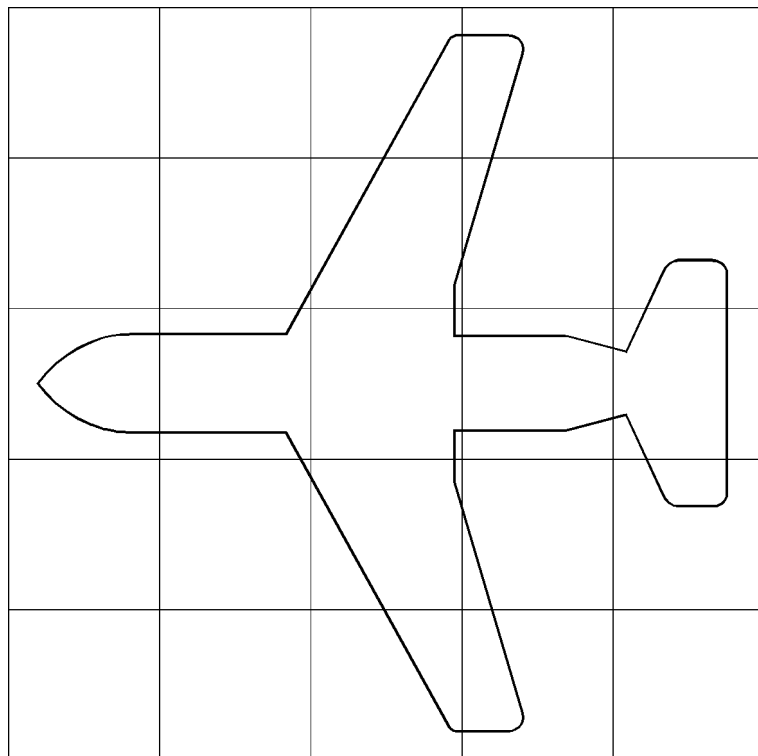

S18

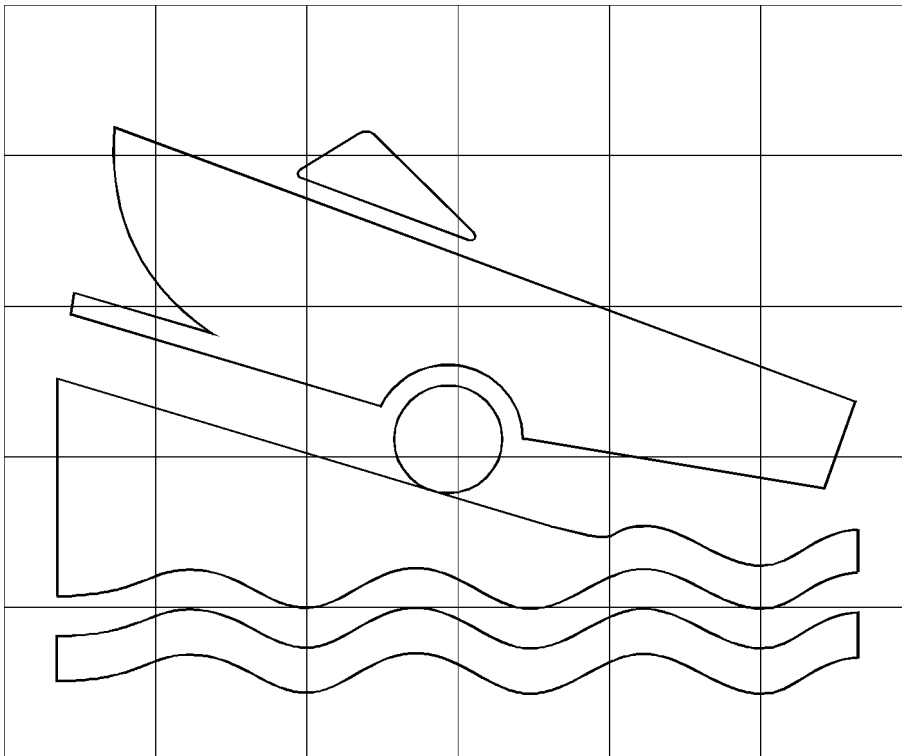

S19

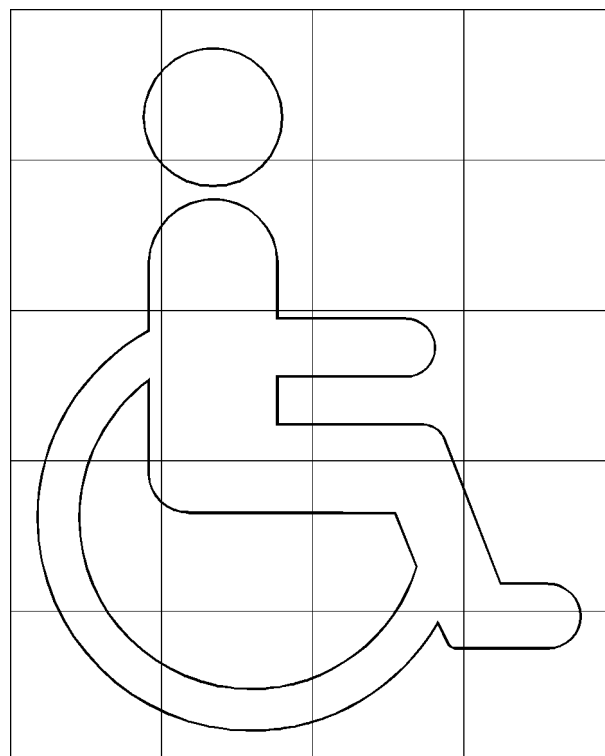

S20

8.8 SIGN DESIGNATION, MAXIMUM SIZES AND TYPICAL SIGN LAYOUTS

8.8.1 MOTORIST SERVICE SIGN DESIGNATION AND MAXIMUM SIZES

Sign	Sign Number	Maximum Size—widths determined by using maximum size symbols (mm)
Advance signs: Roadside mounted for services on the left/right (MS - 1.1 to MS - 1.4)		
One service	MS - 1.1A MS - 1.1B	641 × 1010 857 × 1350
Two services	MS - 1.2A MS - 1.2B	950 × 830 1270 × 1110
Three services	MS - 1.3A MS - 1.3B	1370 × 830 (or 950 × 1190) 1830 × 1100 (or 1270 × 1590)
Four services	MS - 1.4A MS - 1.4B	950 × 1190 1270 × 1590
Advance signs: Roadside mounted for services on a side road to the left/right (MS - 2.1 to MS - 2.4)		
One service	MS - 2.1A MS - 2.1B	641 × 1010 857 × 1350
Two services	MS - 2.2A MS - 2.2B	1083 × 830 1450 × 1110
Three services	MS - 2.3A MS - 2.3B	1370 × 830 (or 1083 × 1190) 1830 × 1110 (or 1450 × 1590)
Four services	MS - 2.4A MS - 2.4B	1083 × 1190 1450 × 1590
Position signs: Chevron type (MS - 3.1 to MS - 3.4)		
One service	MS - 3.1A MS - 3.1B	970 × 470 1285 × 630
Two services	MS - 3.2A MS - 3.2B	1390 × 470 1845 × 630
Three services	MS - 3.3A MS - 3.3B	1830 × 470 2405 × 630
Four services	MS - 3.4A MS - 3.4B	2250 × 470 2965 × 630
Position signs: Rectangular type with a direction arrow (MS - 4.1 to MS 4.4)		
One service	MS - 4.1A MS - 4.1B	530 × 794 710 × 1062
Two services	MS - 4.2A MS - 4.2B	1254 × 470 1675 × 630
Three services	MS - 4.3A MS - 4.3B	950 × 1154 1270 × 1542
Four services	MS - 4.4A MS - 4.4B	950 × 1154 1270 × 1542

TABLE 8.6: MOTORIST SERVICE SIGN DESIGNATION AND MAXIMUM SIZES.

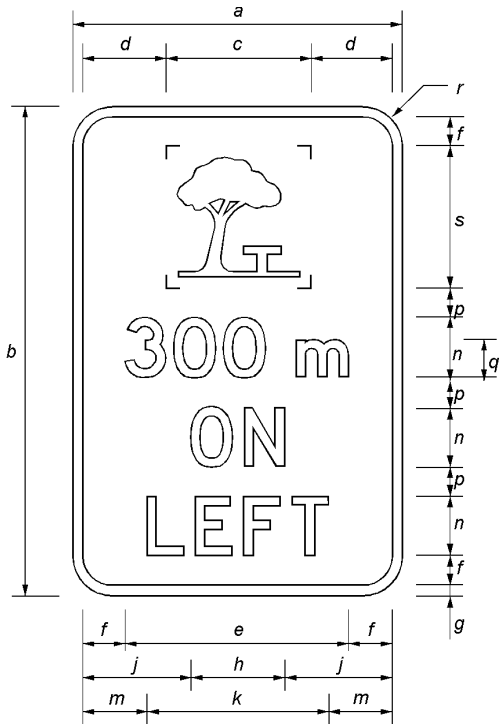

	a	b	c	d	e	f
MS - 1.1A	641	1010	300	146	471	60
MS - 1.1B	857	1350	400	194	627	80

g	h	j	k	m	n
25	197	197	371	110	120DM
35	264	262	497	145	160DM

p	q	r	s
60	80 Mod.E LC	125	300
80	105 Mod.E LC	170	400

Note: Motorist service signs have white letters, numerals, symbols and borders on a blue background, and may be fully reflectorised.

MS - 1.1 SIGN

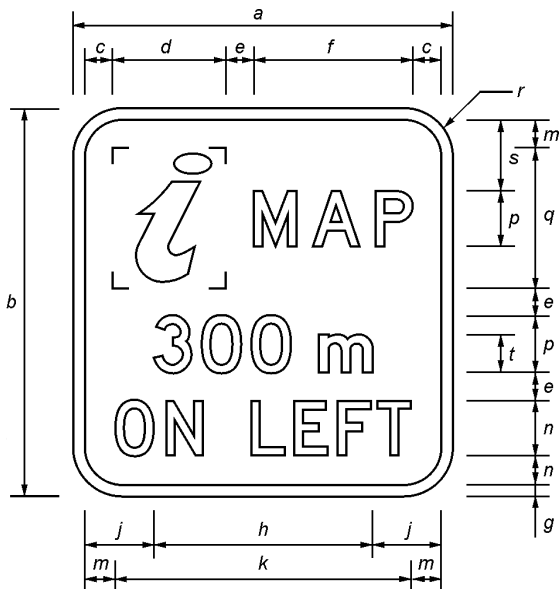

	a	b	c	d	e	f
MS - 1.2A	809	830	61	240	60	337
MS - 1.2B	1088	1110	84	320	80	450

g	h	j	k	m	n
25	471	144	639	60	120DN
35	627	196	858	80	160DN

p	q	r	s	t
120DM	300	105	175	80 Mod. E LC
160DM	400	140	235	105 Mod. E LC

Note: Motorist service signs have white letters, numerals, symbols and borders on a blue background, and may be fully reflectorised.

MS - 1.2 SIGN

FIGURE 8.32 TYPICAL LAYOUTS FOR MS - 1.1 AND MS - 1.2 SIGNS

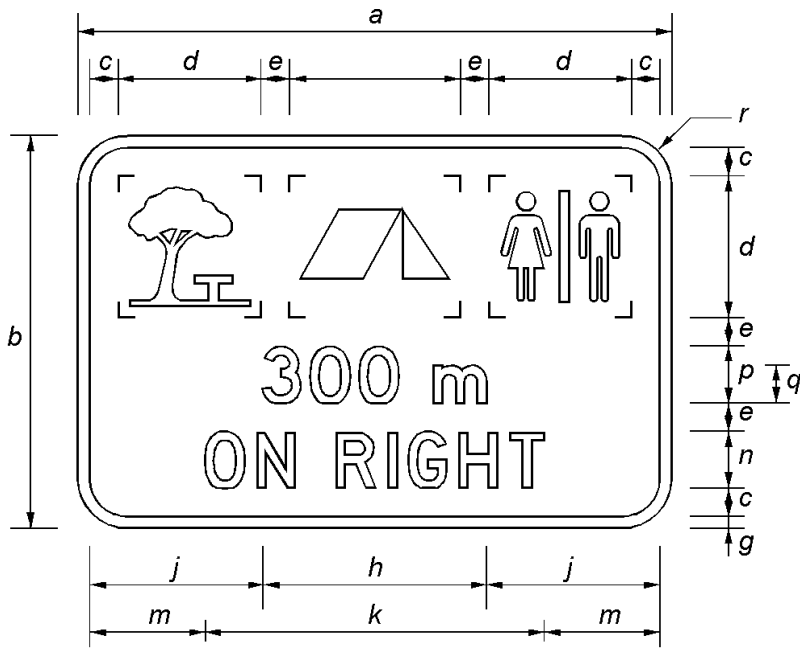

	a	b	c	d
MS - 1.3A	1250	830	60	300
MS - 1.3B	1670	1110	80	400

e	f	g	h	j	k
60	360	25	471	365	714
80	480	35	627	486	956

m	n	p	q	r
243	120D N	120D M	80 Mod. E LC	105
322	160D N	160D M	105 Mod. E LC	140

Note: Motorist service signs have white letters, numerals, symbols and borders on a blue background, and may be fully reflectorised.

MS - 1.3 SIGN

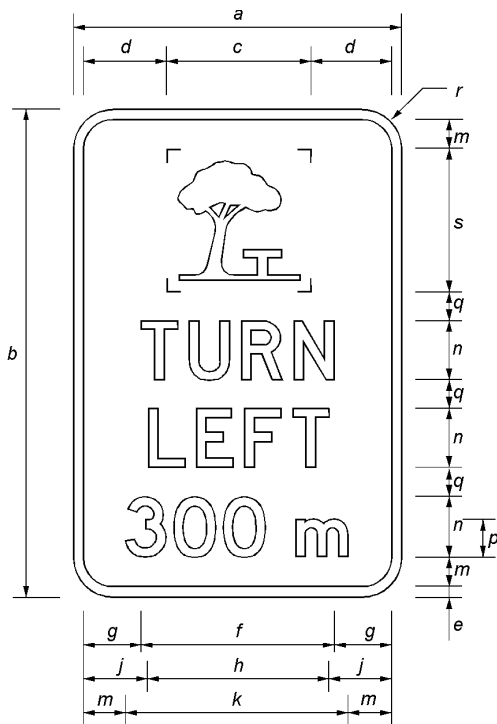

	a	b	c	d	e	f
MS - 2.1A	641	1010	300	146	25	419
MS - 2.1B	857	1350	400	194	35	560

g	h	j	k	m	n
86	371	110	471	60	120DM
144	497	145	627	80	160DM

p	q	r	s
80 Mod. E LC	60	130	300
105 Mod. E LC	80	170	400

Note: Motorist service signs have white letters, numerals, symbols and borders on a blue background, and may be fully reflectorised.

MS - 2.1 SIGN

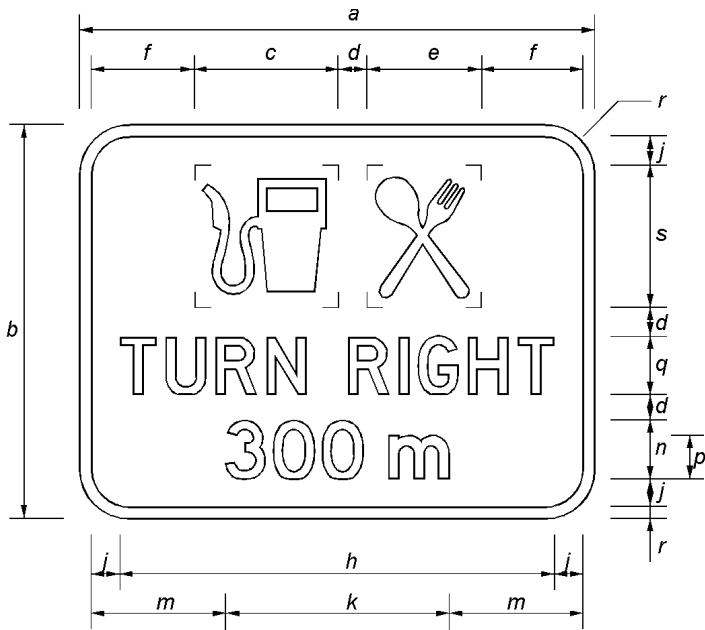

	a	b	c	d	e
MS - 2.2A	1083	830	300	60	240
MS - 2.2B	1450	1110	400	80	320

f	g	h	j	k	m
217	25	913	60	471	281
290	35	1220	80	627	377

n	p	q	r	s
120DM	80 Mod. E LC	120 DN	105	300
160DM	105 Mod. E LC	160 DN	140	400

Note: Motorist service signs have white letters, numerals, symbols and borders on a blue background, and may be fully reflectorised.

MS - 2.2 SIGN

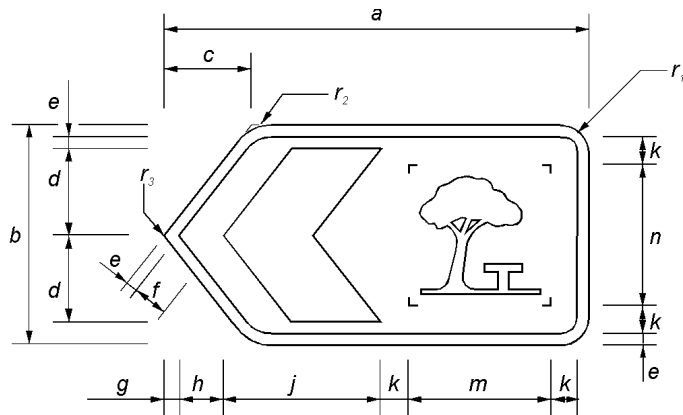

Refer to Figure 8.44 for chevron stripe details.

	a	b	c	d	e	f	g	h	j	k	m	n	r ₁	r ₂	r ₃
MS - 3.1A	905	470	185	210	25	75	32	95	335	60	300	300	60	90	20
MS - 3.1B	1205	630	245	280	35	105	45	134	440	80	400	400	80	120	20

Note: Motorist service signs have white letters, numerals, symbols and borders on a blue background, and may be fully reflectorised.

MS - 3.1 SIGN

FIGURE 8.34 TYPICAL LAYOUTS FOR MS - 2.2 AND MS - 3.1 SIGNS

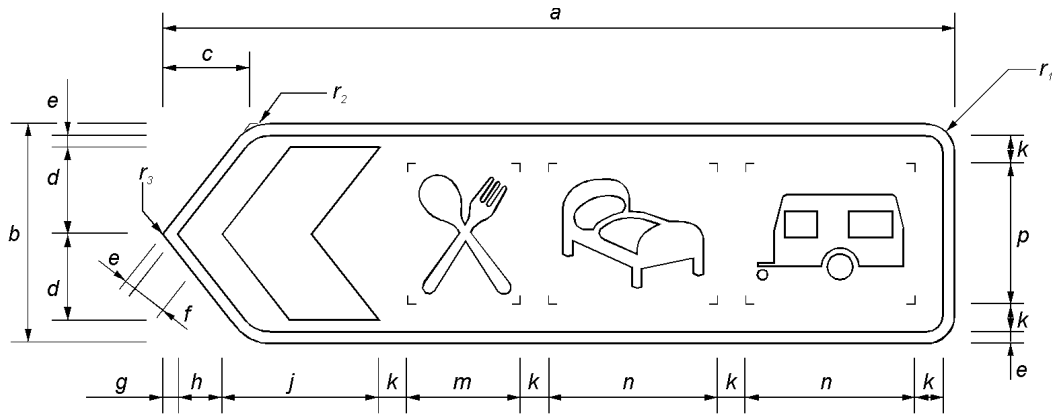

	a	b	c	d	e	f	g	h	j	k	m	n	p	r ₁	r ₂	r ₃
MS - 3.3A	1687	470	185	210	25	75	32	95	335	60	240	360	300	60	90	20
MS - 3.3B	2254	630	245	280	35	105	45	134	440	80	320	480	400	80	120	20

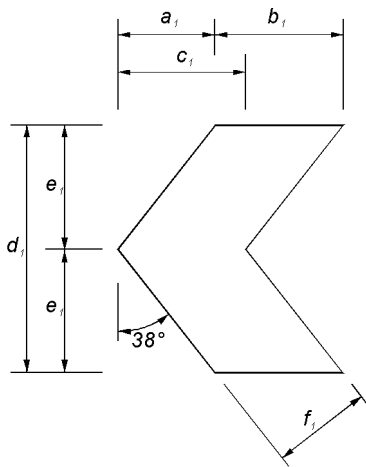

CHEVRON STRIPE DETAILS

	a ₁	b ₁	c ₁	d ₁	e ₁	f ₁
A-size signs	145	190	190	370	185	114
B-size signs	190	250	250	490	245	151

Note: Motorist service signs have white letters, numerals, symbols and borders on a blue background, and may be fully reflectorised.

MS - 3.3 SIGN

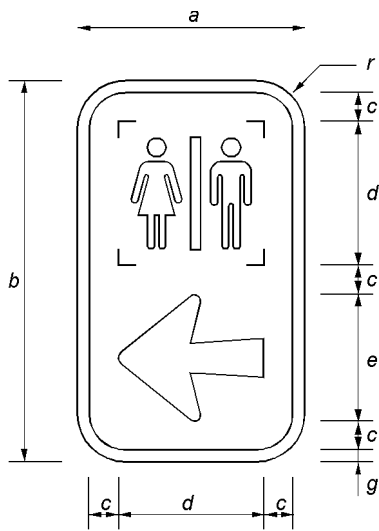

	<i>a</i>	<i>b</i>	<i>c</i>	<i>d</i>	<i>e</i>	<i>g</i>	<i>r</i>
MS - 4.1A	470	794	60	300	264	25	100
MS - 4.1B	630	1062	80	400	352	35	130

Note: Motorist service signs have white letters, numerals, symbols and borders on a blue background, and may be fully reflectorised.

MS - 4.1 SIGN

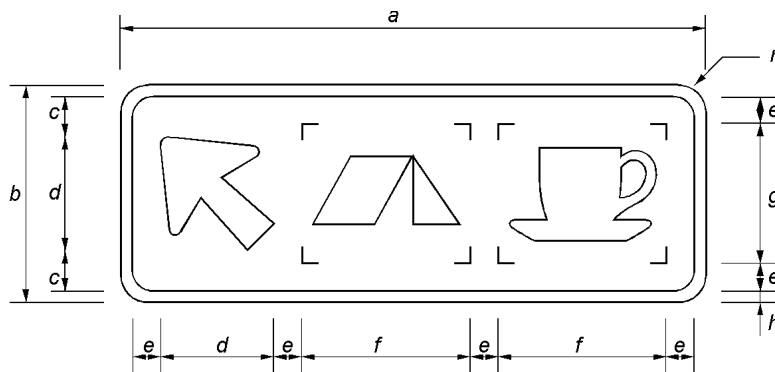

	<i>a</i>	<i>b</i>	<i>c</i>	<i>d</i>	<i>e</i>	<i>f</i>	<i>g</i>	<i>h</i>	<i>r</i>
MS - 4.3A	1254	470	88	244	60	360	300	25	60
MS - 4.3B	1675	630	123	325	80	480	400	35	80

Note: Motorist service signs have white letters, numerals, symbols and borders on a blue background, and may be fully reflectorised.

MS - 4.3 SIGN

FIGURE 8.36 TYPICAL LAYOUTS FOR MS - 4.1 AND MS - 4.3 SIGNS

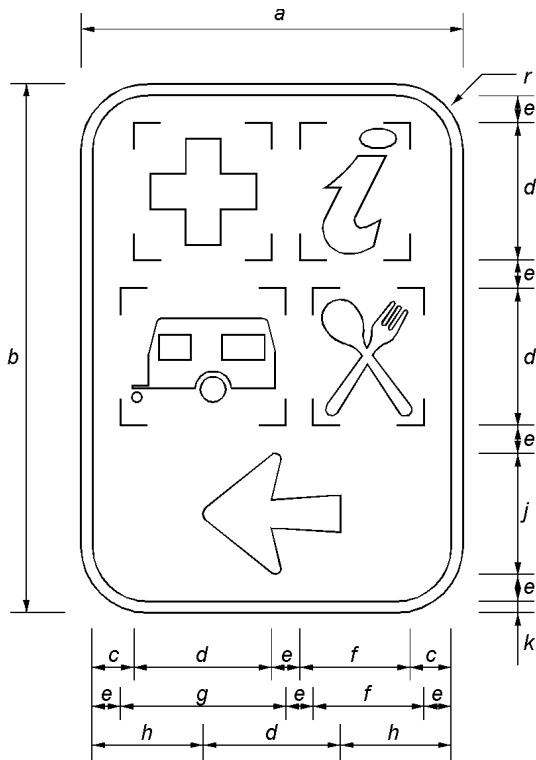

	a	b	c	d	e	f
MS - 4.4A	830	1154	90	300	60	240
MS - 4.4B	1110	1542	120	400	80	320

g	h	j	k	r
360	240	264	25	145
480	320	352	35	195

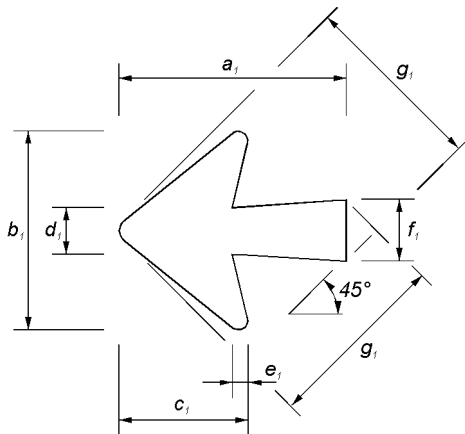

TYPE D DIRECTION ARROW DETAILS

	a_1	b_1	c_1	d_1
A-size signs	300	264	169	60
B-size signs	400	352	226	80

e_1	f_1	g_1	r_1
20	82	244	12
27	109	325	16

Note: Motorist service signs have white letters, numerals, symbols and borders on a blue background, and may be fully reflectorised.

MS - 4.4 SIGN